

Maximum quality in every application

COLD RECYCLERS AND SOIL STABILIZERS WR SERIES

WR 200 (i) | WR 240 (i) | WR 250 (i)



THREE MACHINES - WORLD-CLASS TIMES THREE



The WR series' range of applications includes soil treatment, consolidation in road construction, and cold recycling of asphalt roads.

The Compact Machine - The WR 200(i) stands out thanks to its compact dimensions and reduced weight - this usually means it can be transported without a special permit.

The Multipurpose Machine - The WR 240(i) is ideal for challenging tasks with increased power requirements.

The Powerful Machine - The WR 250(i) is the high-performance machine in the WR series, designed to meet the greatest challenges.

The WR series is characterized by its outstanding milling and mixing performance in combination with unmatched engine power.

The original WIRTGEN **DURAFORCE** milling and mixing rotors guarantee maximum efficiency and perfect mixing results with all models.



WIRTGEN SOIL STABILIZERS



TRACTOR-TOWED STABILIZERS

- > Working width up to 2,500 mm
- > Working depth to 500 mm



SOIL STABILIZERS AND COLD RECYCLERS (WR SERIES)

- > Working width up to 2,400 mm
- > Working depth to 560 mm

OVERVIEW OF HIGHLIGHTS

Perfectly Equipped

01 Perfect Ergonomics and Handling

- > Automatic functions that can be saved and accessed at the touch of a button for frequently repeated work processes
- > Intuitive operating concept with ergonomically shaped, intuitively arranged controls in both arm consoles
- > Comfortable operator's seat that can be adjusted to different body sizes for productive and fatigue-free work over long periods of time
- > Plenty of space, comfortable interior, temperature control inside the cab for operator comfort
- > Cabin with ROPS / FOPS standards for maximum operator safety

02 Optimal Visibility and Comprehensive Camera System

- > Wide fields of vision and generously sized mirrors provide an ideal overview of the site
- > Hydraulic, laterally shiftable cabin and operator's seat that can be rotated by 90° for a clear view of the entire right-hand working edge
- > Reverse assist system featuring helpful graphics for fast reversing with excellent visibility
- > Up to four cameras on the machine for full visibility of key work processes and areas
- > Comprehensive lighting equipment for optimum visibility when working at night



03 Outstanding Off-Road Capability

- > Tried-and-tested four-way tilting to quickly compensate for uneven terrain and guarantee precise working results
- > Electronic cross-slope sensor for adjusting and maintaining the required cross slope
- > Powerful all-wheel drive for sustained maximum traction on difficult surfaces
- > Intelligent machine weight distribution for balanced traction
- > Load-dependent automatic power control to regulate the required machine advance rate

04 Efficient Steering System

- > Sensitive electro-hydraulic steering system, combinable with the optional **AutoTrac™** steering assistant for ultimate precision on the construction site and fatigue-free working
- > Three different steering modes for maximum flexibility on the job site
- > Minimum turning radius of only 3,150 mm for fast maneuvering in the tightest spaces



05 High-Precision WPT - WIRTGEN PERFORMANCE TRACKER

- > Automatic determination of mixing performance for exact project accounting and analysis of savings

06 Efficient Engine and State-Of-The-Art Diagnostic Systems

- > Modern, powerful diesel engine ideally suited for long-lasting, high-performance applications
- > Fully electronic engine management for reduced diesel consumption
- > High-tech diagnostic technology including maintenance diagnostics, parameter settings, and troubleshooting can be easily accessed via the main display in the cabin
- > Machine equipped with automatic self-diagnostics to automatically monitor valves, sensors, and control components

07 Excellent Milling and Mixing Performance

- > Only one model of wear-resistant **DURAFORCE** milling and mixing rotor for maximum flexibility in all applications
- > Engine and cutting power perfectly synchronized for high-performance operation
- > Particularly heavy-duty, wear-resistant quick-change toolholder system for long, effective periods of operation and minimum setup times
- > Nine or twelve different rotor speeds to perfectly adapt operations to the sub-base and achieve homogeneous mixing results
- > Hydraulic drum rotation device for easy and convenient pick changes with engine switched off

08 High-Precision Metering Systems for Binding Agents

- > Heavy-duty, microprocessor-controlled spraying systems to ensure that binding agents and water are metered exactly according to specifications
- > **VARIO** injection bar - variable nozzles enable the adjustment of injection pressure
- > Easy-to-read displays and easily adjustable metering parameters for high-quality mixing results
- > Easy activation and deactivation of individual spray nozzles to vary the spray width
- > Regular, automatic self-cleaning of the spray nozzles with a lifetime functional warranty
- > Optional, built-in S-Pack binding agent spreader for dust-free binding agent spreading

A WIDE RANGE OF APPLICATIONS

Perfect Soil Stabilizer

The WIRTGEN WR series features a wide range of different models to suit every soil stabilization and cold recycling application. Soil stabilization outperforms soil replacement thanks to fewer truck trips, shorter construction times, conserved resources, and lower CO₂ emissions.

The WR soil stabilizer uses its powerful milling and mixing rotor to mix pre-spread binding agents such as lime or cement into existing soil with insufficient bearing capacity, transforming it into a high-grade building material right on the spot.

The resulting homogeneous mixture of soil and binding agent offers excellent tensile, compressive, and shear strength, long-term resistance to water and frost, and volume stability. Typical applications include the construction of paths, roads, highways, routes, parks and sports fields, commercial zones, industrial parks, airfields, dams, backfilling, and landfills.

In addition, perfect ergonomics and visibility, high performance and mixing quality, outstanding off-road capabilities, automatic features, and many other highlights make the WR the unrivaled leader for high output at low cost on any soil stabilization job site.

THE WR SERIES COVERS ALL OF THE SOIL STABILIZATION PERFORMANCE CLASSES IN AN IDEAL MANNER.

	WR 200 (i)	WR 240 (i)	WR 250 (i)
Full performance range	500 - 8,000 m ² / day	1,000 - 10,000 m ² / day	2,000 - 15,000 m ² / day
Ideal performance range	1,000 - 5,000 m ² / day	4,000 - 8,000 m ² / day	6,000 - 12,000 m ² / day

Working direction



Materials Processing During Soil Stabilization

- 01 Pre-spread binding agent
- 02 **DURAFORCE** milling and mixing rotor
- 03 Processed, homogeneous soil / binding agent mixture



01 - 04 Soil stabilization involves transforming sub-bases with insufficient bearing capacity into soil that is perfect for paving and compaction.

04



A WIDE RANGE OF APPLICATIONS

Perfect Soil Stabilizer

Homogenization



Stabilizer



Compactor

Soil stabilization with Lime



Binding agent spreader



Stabilizer

Soil stabilization with Cement



Binding agent spreader



Water tanker



Stabilizer

In the homogenization process, the WR's powerful milling and mixing rotor granulates the native soil without the addition of binding agents and loosens it. While the JOHN DEERE motor

grader grades the homogeneous soil mixture that is produced, various HAMM rollers take care of the compaction process.



Motor grader



Compactor

In the soil stabilization process, the all-wheel-drive Streumaster spreads the binding agent. Behind the binding agent spreader, the powerful milling and mixing rotor of the WR homogeneously mixes the existing soil with the pre-spread binding

agent. While the JOHN DEERE motor grader grades the homogeneous soil mixture that is produced, various HAMM rollers take care of the compaction process.



Compactor



Motor grader



Compactor

To produce a new, cement-treated base layer, a Streumaster binding agent spreader first spreads a layer of cement, followed by a water tanker. The WR's powerful milling and mixing rotor homogeneously mixes the material and the pre-spread

cement. At the same time, water is sprayed into the mixing chamber by means of an injection bar. While the JOHN DEERE motor grader grades the processed base layer material, various HAMM rollers take care of the compaction process.



Compactor



Motor grader



Tandem roller



Pneumatic tired roller

A WIDE RANGE OF APPLICATIONS

High-Performance Cold Recycler

Over time, the steady increase in car and truck traffic causes structural damage to the individual layers of asphalt road surfaces and reduces their bearing capacity. Used as a recycler, the WR eliminates these deficits quickly, cost-effectively, and in a resource-friendly manner. This is because it's equipped with a powerful milling and mixing rotor as well as state-of-the-art spraying systems. The cold recycler uses the milling and mixing rotor to mill asphalt pavements, granulates them, sprays binder and water in precisely measured doses, and mixes it all together in a single operation. The new base layers produced on site then stand out thanks to their exceptional bearing capacity.

Cement, water, bitumen emulsion, and foamed bitumen can be used as additives or binding agents. High-precision metering; consistently high mix quality; clear, simple operation; and exact leveling guarantee optimum results. The WR series of machines are perfect for use across all performance classes - from recycling thin asphalt layers on secondary roads with little traffic to recycling thick asphalt layers on highly frequented highways that must withstand significant loads.

THE WR SERIES COVERS THE ENTIRE SPECTRUM OF COLD RECYCLING APPLICATIONS.

	WR 200 (i)	WR 240 (i)	WR 250 (i)
Ideal performance range	Up to 800 m ² / h	Up to 1,000 m ² / h	Up to 1,200 m ² / h
Recyclable asphalt thickness	10 - 15 cm	15 - 20 cm	20 - 25 cm

Working direction

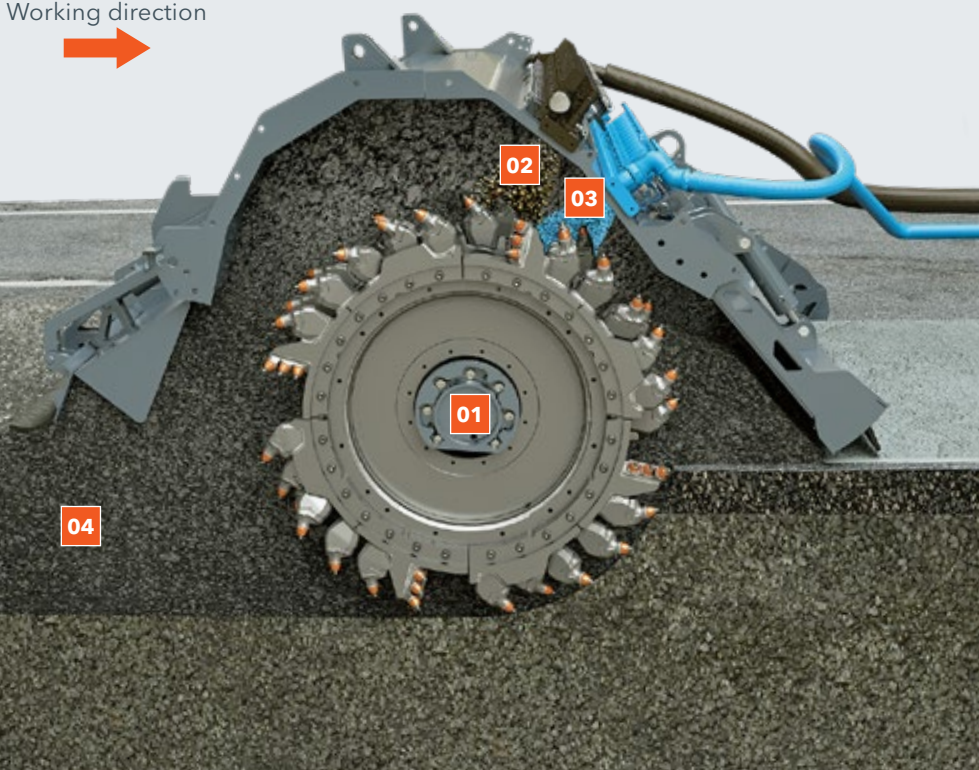

Materials Processing During Cold Recycling

- 01** DURAFORCE
milling and mixing rotor
- 02** Sprayed-in foamed bitumen
- 03** Sprayed-in water
- 04** Processed, homogeneous material



01 - 04 In cold recycling, damaged asphalt layer are granulated, mixed with binding agents, processed, compacted, and repaved.



04

A WIDE RANGE OF APPLICATIONS

High-Performance Cold Recycler

Recycling with Pre-Spread Cement



Recycling with Pre-Spread Cement and Bitumen Emulsion



Recycling with Pre-Spread Cement and Foamed Bitumen

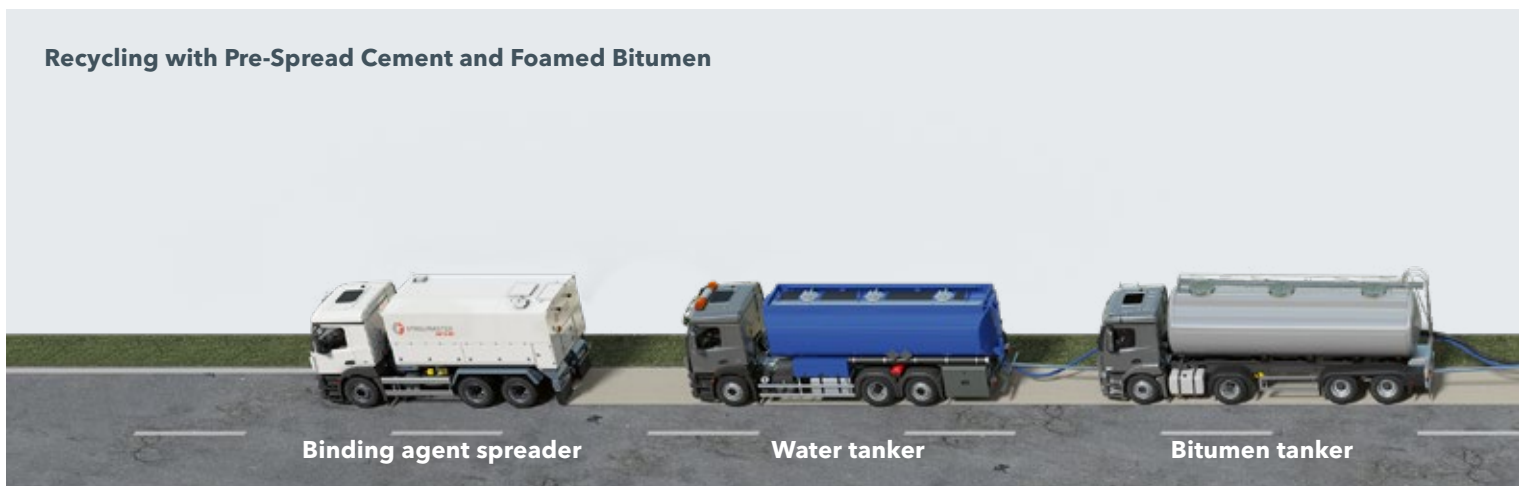

To produce a cement-treated base layer, a Streumaster binding agent spreader first spreads a layer of cement, followed by a water tanker. The WR's powerful milling and mixing rotor granulates the damaged layers. At the same time, cement and

sprayed water are mixed in. While the JOHN DEERE motor grader finish-grades the homogeneous soil mixture that is produced, various Hamm rollers take care of the compaction process.



Compactor



Motor grader



Tandem roller



Pneumatic tired roller

A Streumaster binding agent spreader dispenses small quantities of cement, followed by a water tanker and an emulsion tanker. The WR's powerful milling and mixing rotor granulates the damaged layers. At the same time, the pre-spread cement is mixed in and emulsion and water are

sprayed into the mixing chamber via two separate micro-processor-controlled injection bars. While the JOHN DEERE motor grader finish-grades the homogeneous soil mixture that is produced, various HAMM rollers take care of the compaction process.



Recycler



Compactor



Motor grader



Tandem roller



Pneumatic tired roller

A Streumaster binding agent spreader dispenses small quantities of cement, followed by a water tanker and a bitumen tanker. The WR's powerful milling and mixing rotor granulates the damaged layers. At the same time, the pre-spread cement is mixed in and foamed bitumen and water are sprayed into

the mixing chamber via two separate microprocessor-controlled injection bars. While the JOHN DEERE motor grader finish-grades the homogeneous soil mixture that is produced, various HAMM rollers take care of the compaction process.



Recycler



Compactor



Motor grader



Tandem roller



Pneumatic tired roller

PERFECT ERGONOMICS AND HANDLING

Space and Comfort are the Keys to Success

This is why we've paid special attention to the operator's workplace. The WR's spacious, soundproof cabin features plenty of space to move around, a comfortable interior, and a pleasant inside temperature. A comfortable operator's seat, a powerful air-conditioning and heating system, a radio with CD player, a compressed air connection, an air gun for

cleaning the cabin, backlit controls, and numerous storage options are just some of the many features. They make the operator's work easier, increase their physical comfort and performance, and thus increase the productivity of the entire machine day after day.

01



Climb in and Enjoy the Comfort

Jumbo-size state-of-the-art operator's cabin

Everything under Control

Intuitive control element layout

Ergonomics - Redesigned from the Ground up

The ergonomic highlight of the WR is the anatomically shaped operator's seat with spring and air suspension. It can be adjusted to fit different body sizes and ensures that operators can sit comfortably for many hours. In addition, both arm consoles have ergonomically shaped controls built in - their convenient layout guarantees intuitive operation.

- 01** Intuitively arranged controls and the fully adjustable operator's seat in the spacious cabin offer perfect ergonomics and comfort.
- 02** The multifunctional joystick on the right-hand arm console fits perfectly into the palm of the operator's hand.

All of the machine's key functions have been logically grouped together in the multifunctional joystick on the right-hand arm console and can therefore be operated with effortless ease. The entire operator's seat, including the arm consoles and steering column, can be rotated 90° to either side, giving the operator full visibility of the rear of the machine while maintaining a relaxed posture.



03 - 04 The individually adjustable comfort seat allows the operator to find the perfect position.

PERFECT ERGONOMICS AND HANDLING

The WR Makes Work Easier - Day after Day

On job sites today, you simply have to meet the deadline – even if it means working in adverse weather conditions, the darkness, or at night. This is where our intelligent lighting concept proves its worth. The WR features the following lighting equipment: six work lights on the front of the cabin (optionally available with LEDs), two headlights each on the left and right sides, two cornering lights at the rear, and two spotlights that can be positioned as desired thanks to their magnetic base.

As a result, operations can continue in full swing even after the sun has set. “Welcome and go home” lighting illuminates the area around the machine by means of LED lights when walking towards or away from the WR. And safety always comes first – when working on the engine or radiator, side handrails can be folded up in just a few simple steps. The cabin meets ROPS / FOPS standards and offers maximum operator protection.



01



02



03

- 01** The operator can easily access the spacious cabin.
- 02** The machine can be transported on all standard flat-bed trucks – and the WR 200(i) usually doesn't even need a special permit.
- 03** The comprehensive lighting system fully illuminates all of the machine's main working areas.
- 04** Automatic end-of-cut feature: The milling and mixing rotor as well as the rotor plates at the front and rear move to the preselected position. When reversing, the WR lifts the rotor and completely closes the cut at the end of the lane.

Increased Performance at the Touch of a Button

The WR recycler is equipped with an intelligent automatic system for initiating and stopping the milling process. The operator activates the function via a multifunctional joystick and the WR does the rest automatically: First, the machine lowers quickly and the front and rear rotor plates move into the preselected positions. When the lifting columns are in working position, the milling and mixing rotor lowers into the ground down to the programmed working depth.

The operator then moves the joystick forward and the machine begins to advance. The automatic end-of-cut feature - activated by joystick - closes the cut at the end of each lane in the rotor area.

While the WR continues to travel a few meters, a roller plate completely closes the cut. At the same time, the rotor is lifted slowly and the lifting columns move the machine into transport position.

04

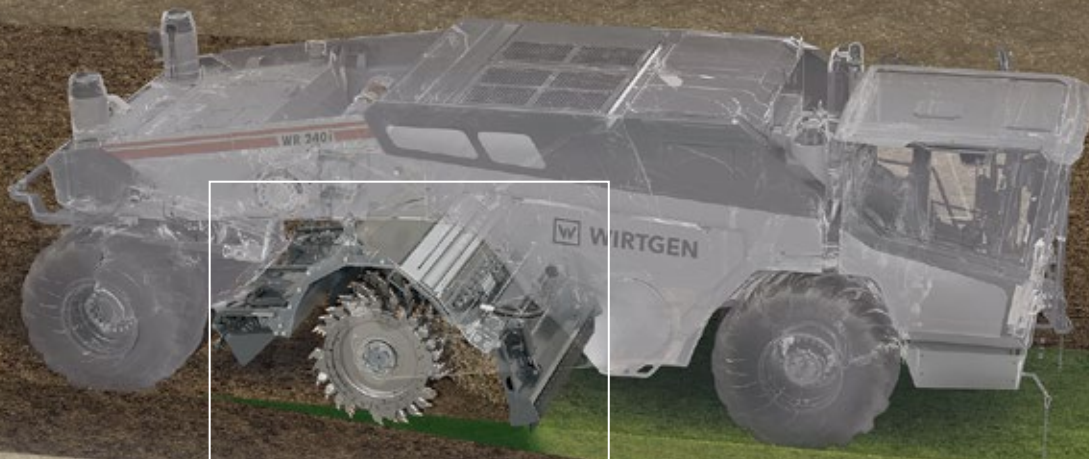

Working direction



Fast and Efficient
Savable automatic functions

Fast Relocation to Next Job
Compact transport dimensions

OPTIMAL VISIBILITY AND COMPREHENSIVE CAMERA SYSTEM



Overview of the Entire Construction Site
Smart all-round vision concept

Keep Sight of the Zero Edge
Operator's cabin with lateral shift capability

Enhanced Visibility Enhances Productivity

Good visibility is critical to safe operations and rapid processes. The WR offers a visibility concept that is unique in the industry: Large glass windows on the left, front, and right sides of the cabin as well as practical mirrors provide an excellent overview of the entire job site. The spacious operator's cabin can be moved to project over the edge of the machine on the right and the operator's seat can be rotated by 90°, offering an unobstructed view of the entire working

edge on the right side. These features make it easy to work flush to the edge without requiring time-consuming follow-up work.

Thanks to the excellent view of the entire working edge on the right side of the machine, recycling operations can be carried out with maximum precision right at the edges of road surfaces. The clear view of the right working edge also makes exact overlaps possible.



01 - 02 The operator's cabin can be moved far to the right hydraulically, allowing the operator to look past a recycling train traveling ahead.

OPTIMAL VISIBILITY AND COMPREHENSIVE CAMERA SYSTEM

01



Perfect Overview of All Important Working Processes
Multi-camera monitoring system

Collision Avoidance System
Reverse assist

02



Camera on left side of machine



Camera at the rear of the machine



Camera at the front rotor plate



Camera at the rear rotor plate

Second-To-None Camera System

Camera systems are increasingly becoming an important tool for monitoring operations and processes on machines where excellent visibility is essential. Even the base version of the WR comes equipped with a rear view camera.

The intelligent reverse assist system supports the machine operator when reversing by displaying driving assistance lines.

The machine can even be equipped with a system consisting of a total of four color, high-resolution cameras - at the rear of the machine, on the left-hand side of the machine, and underneath the machine at the front and rear rotor plates - at the customer's request. If multiple cameras are used, an additional screen is installed to display the camera images.

Keeping an eye on important work processes and areas, such as approaching obstacles or examining the results, significantly increases performance, cost-effectiveness, and quality.

OUTSTANDING OFF-ROAD CAPABILITY

Stable Handling and Ample Ground Clearance

The WR easily negotiates even the most uneven surfaces while maintaining its horizontal alignment at all times. The machine's automatic four-way full-floating axle and electronic cross-slope sensor are key features when it comes to maintaining machine stability and balance. With the help of the sensor, the WR can operate parallel to the surface or at the specified cross slope. The tried-and-tested, four-way full-floating lifting column design quickly and dynamically compensates for any uneven ground. It ensures that the milling and mixing rotor

maintains the desired depth on both the left and right side, ensuring precise working results. The height of the wheels can be adjusted to the left, right, front, or rear in pairs in order to fully adapt the machine to the respective site conditions. When moving sideways across sloping terrain, the operator can use the "roll" feature to adjust the machine to a more comfortable horizontal position. This means the operator also benefits - by being able to work in a relaxed manner while enjoying a comfortable ride.

01



Difficult Terrain is Child's Play

When it comes to high-performance stabilization in deep, muddy terrain, the key word is traction. And the WR has more than enough of it. Extra-large, high-grip tires effectively transfer the power of the high-performance engine to the ground. The tough all-wheel drive continuously delivers maximum traction to each individual, hydrostatically powered wheel. The machine's intelligent weight distribution also helps achieve balanced traction. The automatic power control controls the machine advance rate depending on the load, eliminating the need to switch the differential lock on and off.

When ample ground clearance is required in deep, muddy terrain, the automatic height adjustment via four-way full-floating axle demonstrates its strengths. The travel speed can be infinitely adjusted from standstill to maximum speed during both operation and in transport mode.

The bottom line - the WR is the perfect machine for mixing binding agents into difficult soils.

High Machine Stability

Four-fold pendulum axle system

Optimal Traction

All-wheel drive

02



03



01 Even deep, wet ground is no problem thanks to all-wheel drive.

02 The machine's all-wheel drive distributes power equally to all four wheels.

03 The WR can easily compensate for uneven ground.

PRECISE, SATELLITE-POSITIONING-BASED AUTOTRAC™ STEERING SYSTEM

Thanks to the SF-RTK correction signal, the GNSS positioning-based steering system steers the machine with an accuracy within tolerances of a few centimeters (± 2.5 cm from strip to strip) on the basis of a previously calculated reference strip and a specified overlap of adjacent strips. Working with the system couldn't be easier.

First of all, the machine is driven along a reference strip, which the system saves and stores. This is displayed on the separate 10" control screen supplied with the system and can be interactively adjusted as required. In the next step, the machine operator selects the desired strip overlap, positions the machine in the next strip and activates AutoTrac™. The system now precisely steers the machine with an optimal strip overlap and assures consistent utilization of the machine's ideal working width.

If one considers the sum of the large, avoidable overlaps with neighboring strips that can occur in manual operations, the potential savings the system can bring soon become clear. The project can be completed faster, with lower consumption of fuel and other consumables, and, as a result of this, a reduction of CO₂ emissions. And all of this hand-in-hand with optimal quality of the finished result and a reduction of the operator's workload.

In combination with WPT, the WIRTGEN PERFORMANCE TRACKER, the AutoTrac™ steering system can save up to 10 % of the resources otherwise required for the job.

01



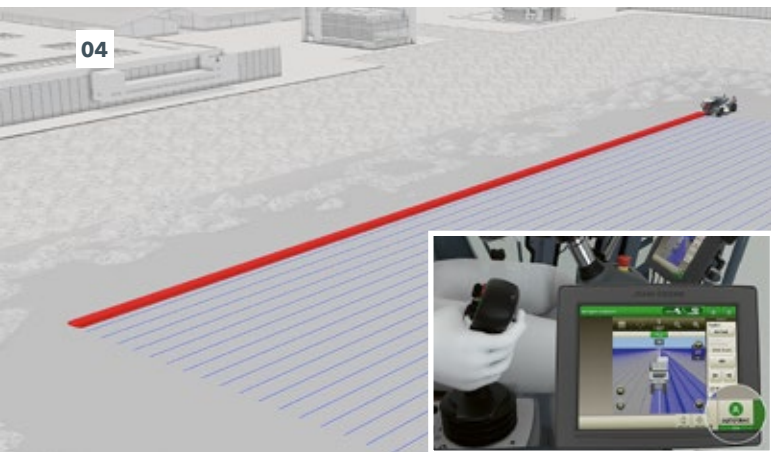
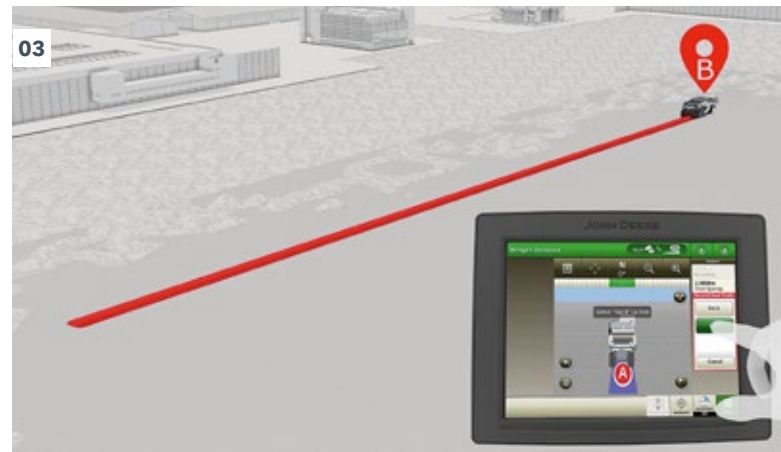

- 01** Typical surface, e.g. after manually controlled soil stabilization without pre-defined overlap..
- 02** The operator completes a strip...
- 03** ... and saves it as a reference strip that can then be copied as often as necessary. The operator selects the desired overlap and starts AutoTrac™.
- 04** The operator starts AutoTrac™ by pressing a button on the joystick.
- 05** The system now precisely steers the WR with an optimal, predefined strip overlap.



05

FIELD-PROVEN STEERING SYSTEM

Fast Maneuvering in Tight Spaces

Thanks to its electrohydraulic “steer-by-wire” steering system, the WR has everything it needs for smooth, even steering. The operator can choose from three different steering modes: straight-ahead, crab steering, or cornering. Each of the three steering modes is the fastest way to reach the destination in its specific area of application. In cornering mode, the WR achieves the minimal turning radius of 4,500 mm. The steering wheel’s innovative oversteering feature allows the rear wheels to be turned even further, in which case the WR can even achieve an extremely tight turning radius of 3,150 mm.

As a result, it even surpasses the very tight turning radius of ordinary passenger cars. The operator can easily switch between the steering modes using the multifunctional joystick, and the currently selected steering mode is always clearly visible. The sensitive steering and the freedom to select the steering mode help make the operator’s job easier. This not only allows them to more effectively focus on delivering top quality results, but also makes them much more productive.

Precise and Effortless Control

Sensitive steering response

Turning Circle Only 3,150 mm

Smart steering system

01



- 01 The extremely tight turning radius allows the machine to turn quickly in the tightest of spaces.
- 02 Different steering modes for easy handling. In cornering mode, the operator can also oversteer the rear axle and achieve an extremely tight turning radius.



02

Straight-Ahead Mode:

The operator steers the front wheels using the steering wheel.

In this mode, the rear wheels automatically remain locked in the straight position, but can be steered separately using the joystick.

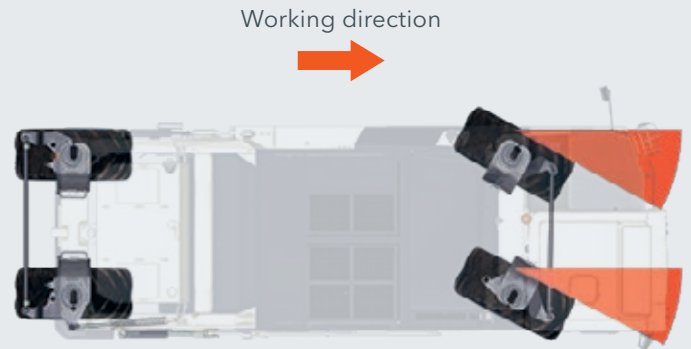

Crab Steering Mode:

All four wheels are steered at the same angle simultaneously via the steering wheel.



Cornering Mode:

The front and rear wheels are steered in sync using the steering wheel, making tight turning circles possible.

Cornering Mode - with Oversteering:

The front and rear wheels are steered in sync using the steering wheel, making tight turning circles possible. When a certain steering angle is reached, the rear wheels can be turned even further via the steering wheel. Oversteering makes even tighter turning circles possible.

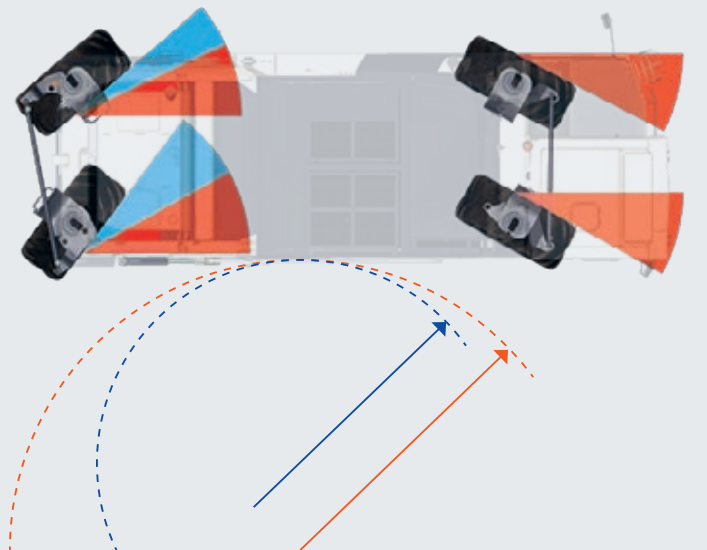

--- = Minimum turning radius in cornering mode: $R_{min} = 4,500$ mm

--- = Minimum turning radius in cornering mode with oversteering $R_{min} = 3,150$ mm

WPT - WIRTGEN - THE HIGH-PRECISION PERFORMANCE TRACKER

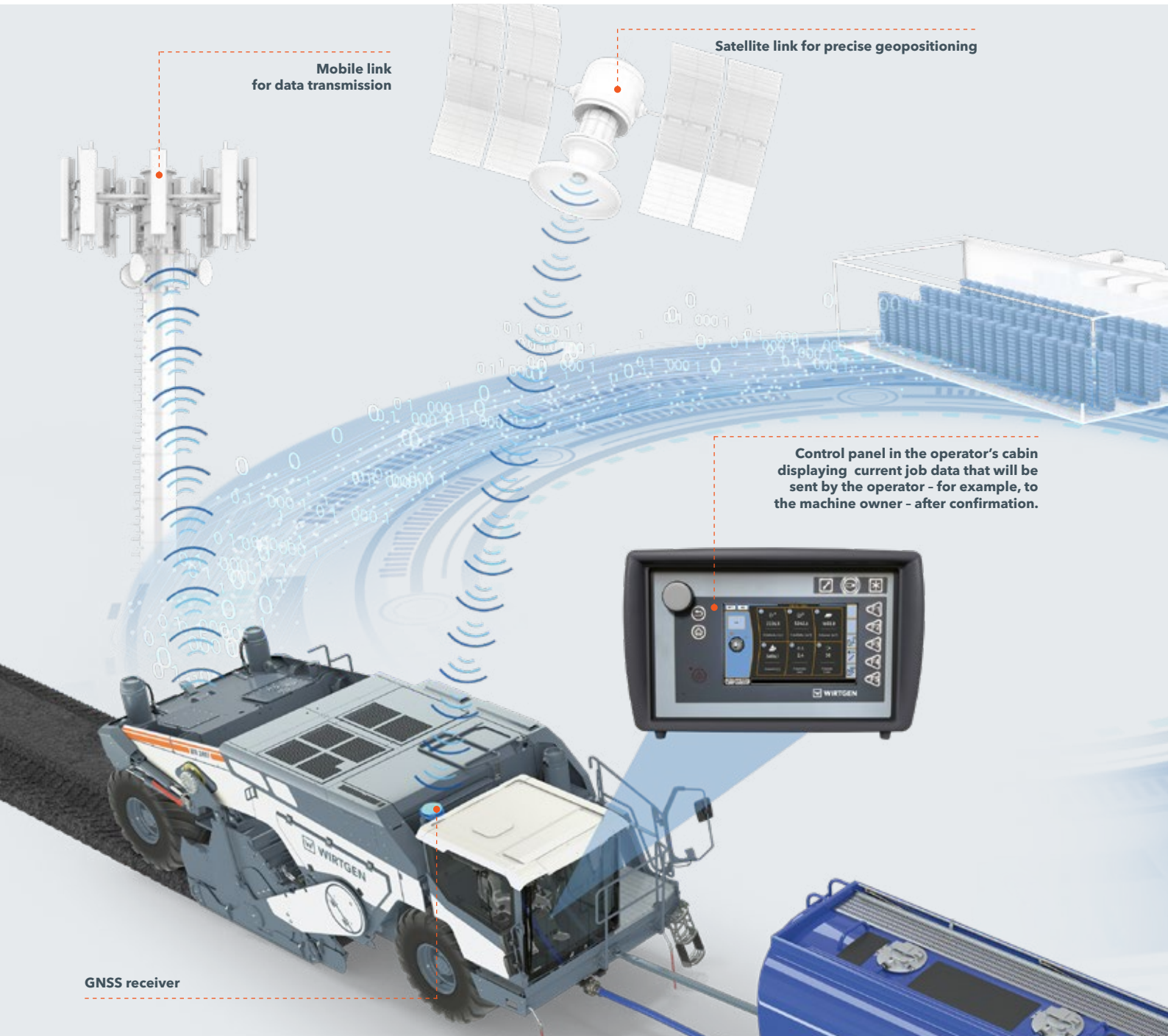

Automatic Mixing Performance Tracker
Precise WPT

Analysis of Saving Potentials
Accounted consumption of resources

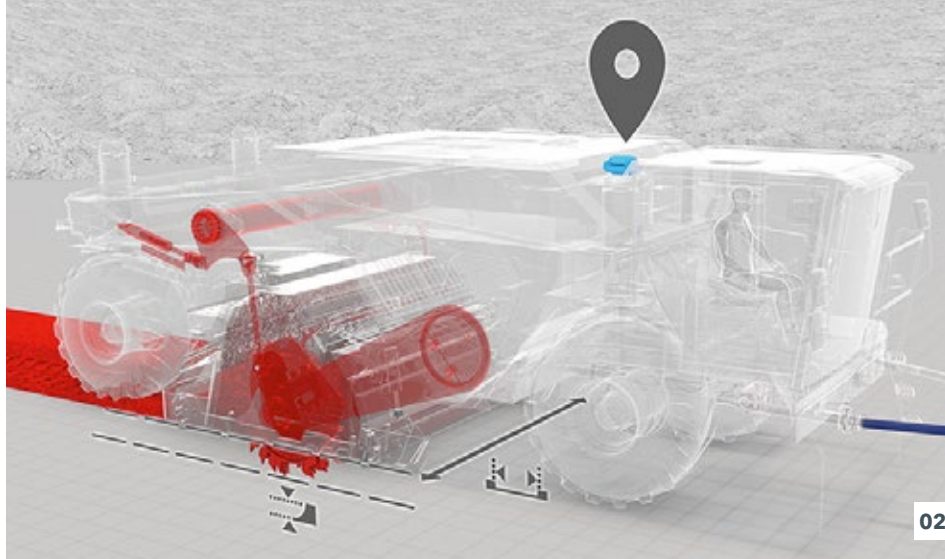

- 01** The operator receives constant information about the current machine and job parameters – at the end of the working day, the data is transmitted to the machine owner simply by pressing a button.
- 02** WPT precisely determines the area and volume performance and the additive quantities with the aid of satellite-based positioning data and the high-precision sensor system on the machine.



Precise Mixing Performance Tracking

WPT (WIRTSCHAFTS PERFORMANCE TRACKER) is a satellite-positioning-based monitoring and tracking system for precise documentation of construction sites. It records all site-specific parameters and documents them as a detailed project site report. After completion of the work (e.g. the end of the working day), the machine operator presses the send button to transmit the data to the WITOS server via the telematic control unit (TCU) of the mobile communication interface. From there, the data are distributed to the designated recipients, e.g. in the form of a report by e-mail.

The GNSS receiver with the licensed SF-RTK correction signal enables accuracy in the range of +/- 2.5 cm from strip to strip, and this with a very quick pull-in time. This enables the documentation of extremely precisely-positioned machine information immediately after the day's work begins, i.e. as soon as the machine is started.

In addition to high-precision GNSS machine position data, the report contains various parameters such as the working width and depth, the distance and area covered, and consumption figures for water, binding agents, diesel fuel, and picks. In addition a separate layer file in PDF format shows the respective working depths and the precise locations at which water and binding agents were added.

The results enable a precise analysis of performance on the construction site, the quality of the results delivered, and the process efficiency. This in turn enables detailed accounting of all processes and the identification of future savings potentials. At the same time, at the end of each shift, the resource planner receives reliable and precise documentation of performance and progress on the construction site without any additional effort.

EFFICIENT ENGINE AND STATE-OF-THE-ART DIAGNOSTIC SYSTEMS

Superior Engine Technology

The WR's state-of-the-art, high-torque diesel engine is perfect for soil stabilization and cold recycling operations requiring maximum performance. But in addition to the muscle, it also uses its "brains" - the intelligent, fully electronic engine management system optimizes engine performance, maintained torque at a constantly high level, even in the event of extreme engine lugging. Ample torque reserves mean that nothing stands in the way of further increases in power output, if required. In addition, automatic speed adjustment reduces diesel consumption.

Rapid On-Board Diagnostics

State-of-the-art measuring technology is by far superior to conventional, manual measuring methods. We have therefore equipped the WR with high-tech diagnostic systems that allow maintenance diagnostics, parameter settings, and troubleshooting to be performed effortlessly via the control panel in the operator's cabin. The machine's automatic self-diagnostic system autonomously monitors valves, sensors, and control components. Numerous clearly visualized pages provide quick and accurate information on the machine's current operating parameters.

01



Constantly Monitored Machine Status

High-tech diagnostic systems

In addition, extended servicing intervals and an intelligent maintenance concept minimize maintenance requirements. The handful of service points are clearly arranged and easily accessible either from the ground or via ladders.

In short, the WR has been designed for maximum operational availability.

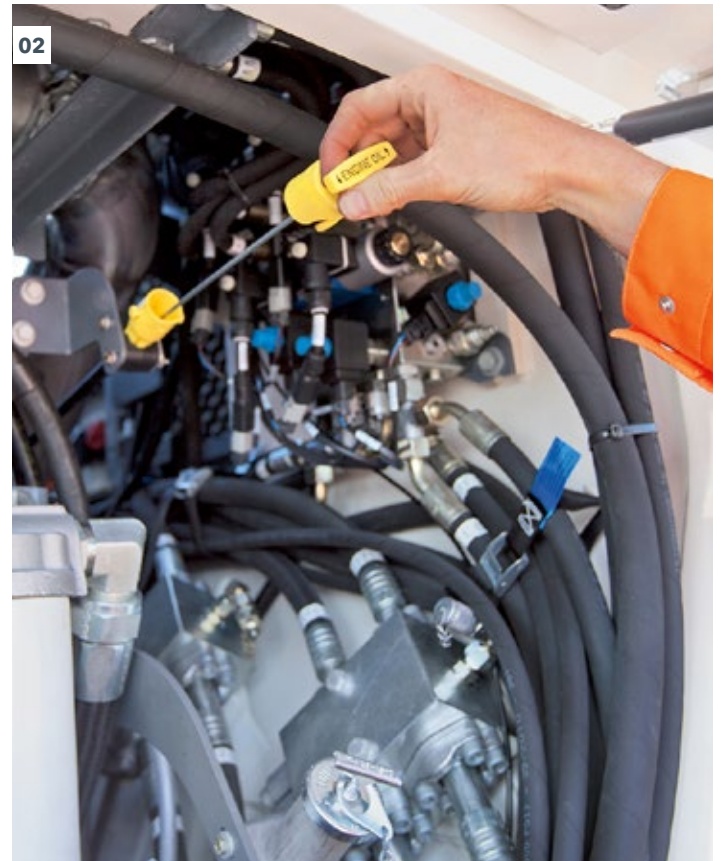

01 Diagnostics and parameter settings are performed via the control display.

02 The oil level can easily be checked from the ground.

03 When opened, the engine cover offers easy access to the engine compartment, hydraulic system, air filter, and pumps.

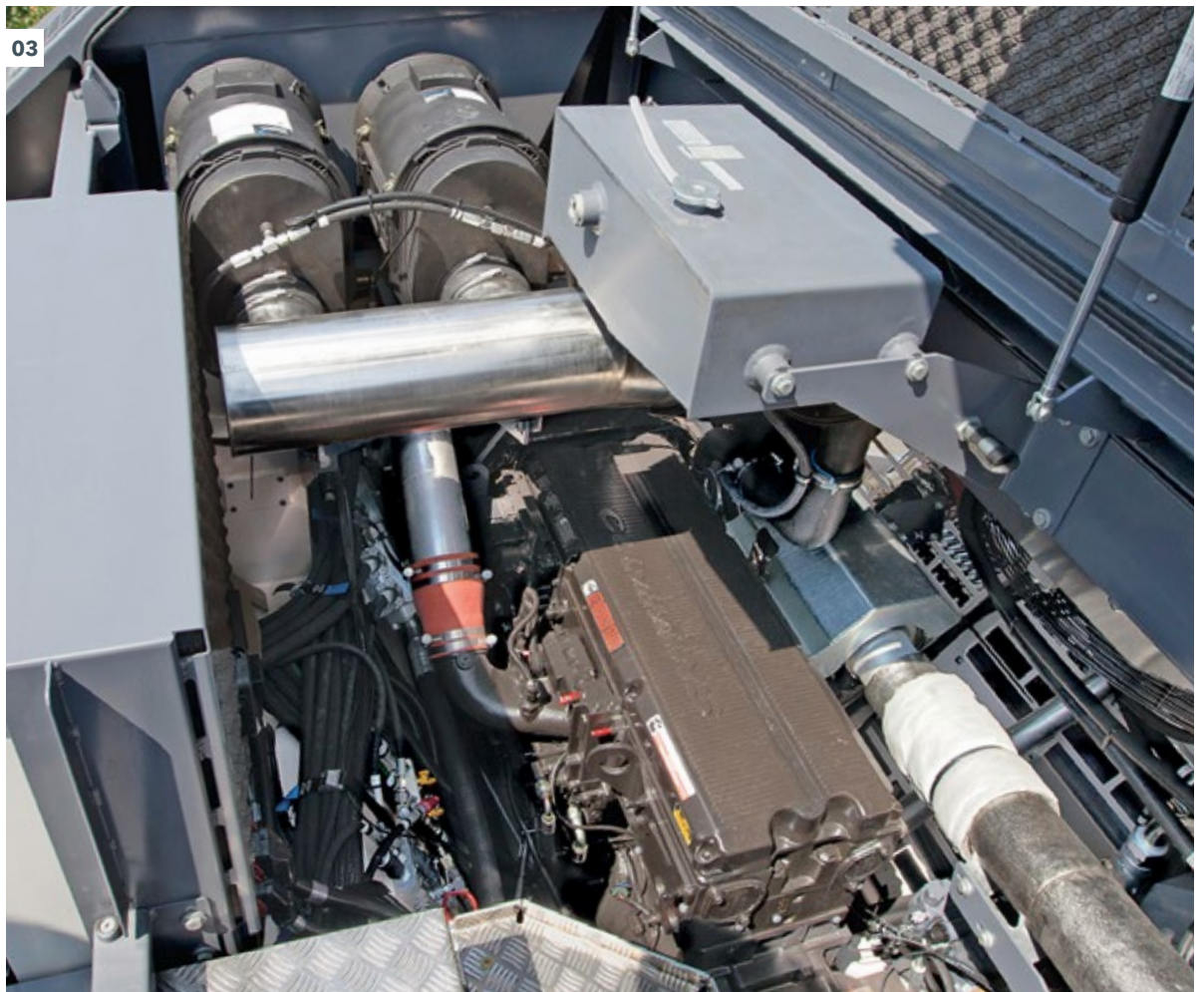

EXCELLENT MILLING AND MIXING PERFORMANCE

THE DIFFERENT MACHINE TYPES OF THE WR SERIES IN COMPARISON

Power Range	WR 200	WR 200 i	WR 240	WR 240 i	WR 250	WR 250 i
Working width	2,000 mm	2,000 mm	2,400 mm	2,400 mm	2,400 mm	2,400 mm
Working depth	0 - 500 mm	0 - 500 mm	0 - 510 mm	0 - 510 mm	0 - 560 mm	0 - 560 mm
Maximum power	315 kW	320 kW	455 kW	455 kW	571 kW	563 kW
Cutting power	1.6 kW / cm	1.6 kW / cm	1.9 kW / cm	1.9 kW / cm	2.4 kW / cm	2.4 kW / cm

Highlights of the DURAFORCE Milling and Mixing Rotor

- 01 Long Service Life and Maintenance Intervals**
 - > Wear-resistant, generation Z picks for demanding stabilization and recycling applications
 - > Heavy-duty HT22 quick-change toolholder system for minimal downtime
- 02 Universal Milling and Mixing Rotor**
 - Highly productive milling and mixing rotor for all soil stabilization, cold recycling, and granulation applications
- 03 Powerful Mixing**
 - Carefully engineered holder base design paired with the large diameter of the milling and mixing rotor for optimum and homogeneous mixing
- 04 High Performance and Perfect Mixing Results**
 - > Tool spacing and cutting tool layout precisely tailored to the machine output (from pick to holder base)
 - > Ideal arrangement of cutting tools for uniform, smooth milling and mixing processes

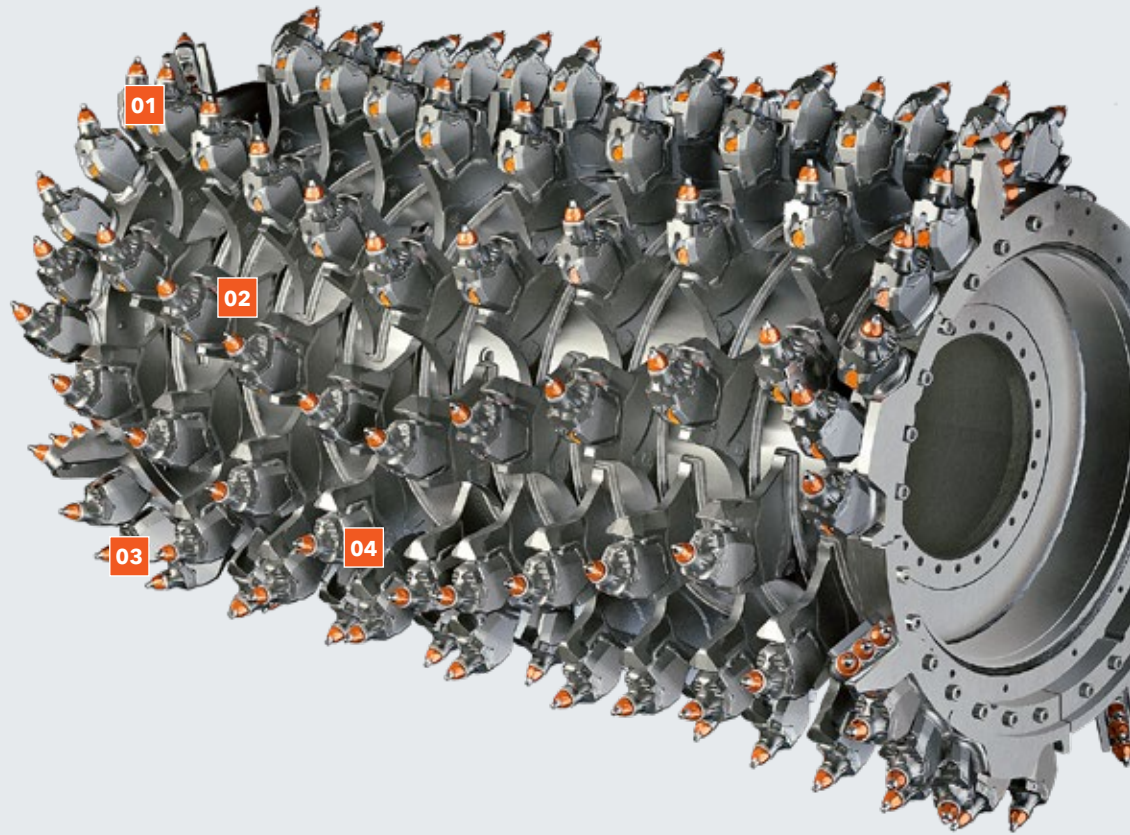

It's The Mix that Counts

Perfectly engineered WIRTGEN milling technology

Maximum Performance

Perfectly matched engine and cutting performance

The Heart of the Machine - The Perfectly Engineered DURAFORCE Milling and Mixing Rotor

Milling technology is our area of expertise, and the extremely wear-resistant WIRTGEN **DURAFORCE** milling and mixing rotor not only transforms difficult soil into a high-quality building material for soil stabilization. And because it offers maximum performance, a long service life, and creates base layers of optimum quality, it also meets the special requirements of cold recycling.

The engine and cutting power of the various models have been perfectly synchronized, and the respective combination of working width and depth allows this power to be used efficiently. The heavy-duty rotor design promotes smooth rotation without any jolts or shocks, thereby reducing wear and tear on

the drive elements. Pick holders have been perfectly arranged on high bases all the way to the edges to guarantee homogeneous mixing of the building materials at any working depth.

The hydraulic drum rotation device moves the rotor into the ideal position for the operator to change the picks without any effort. In addition, the wear-resistant quick-change toolholder system ensures optimum tool rotation, easy pick changes, and long, effective periods of operation.

01 Highlights of the **DURAFORCE** milling and mixing rotor.

02 WIRTGEN milling and mixing rotors guarantee high-quality mix.

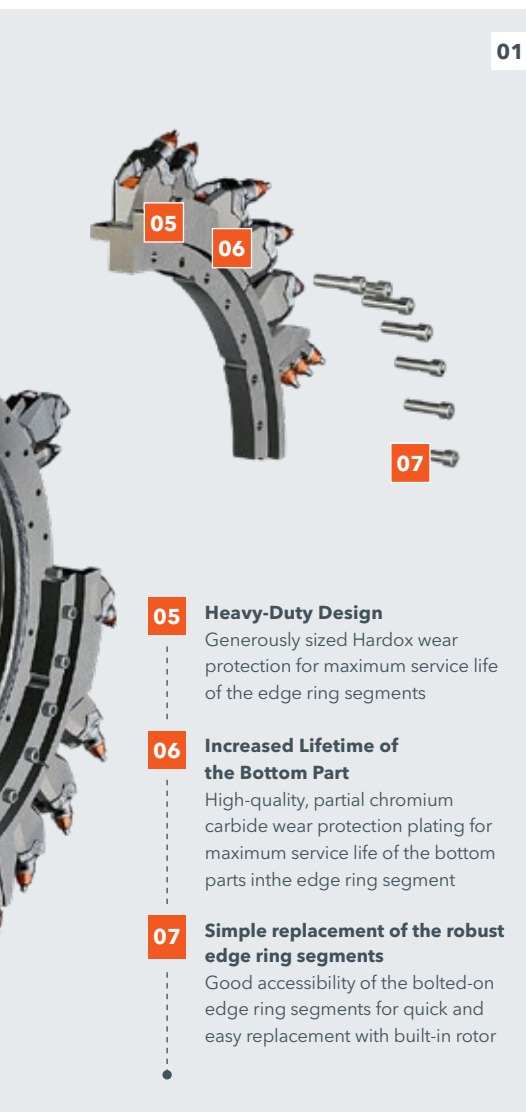

DURAFORCE FOR UNSURPASSED QUALITY



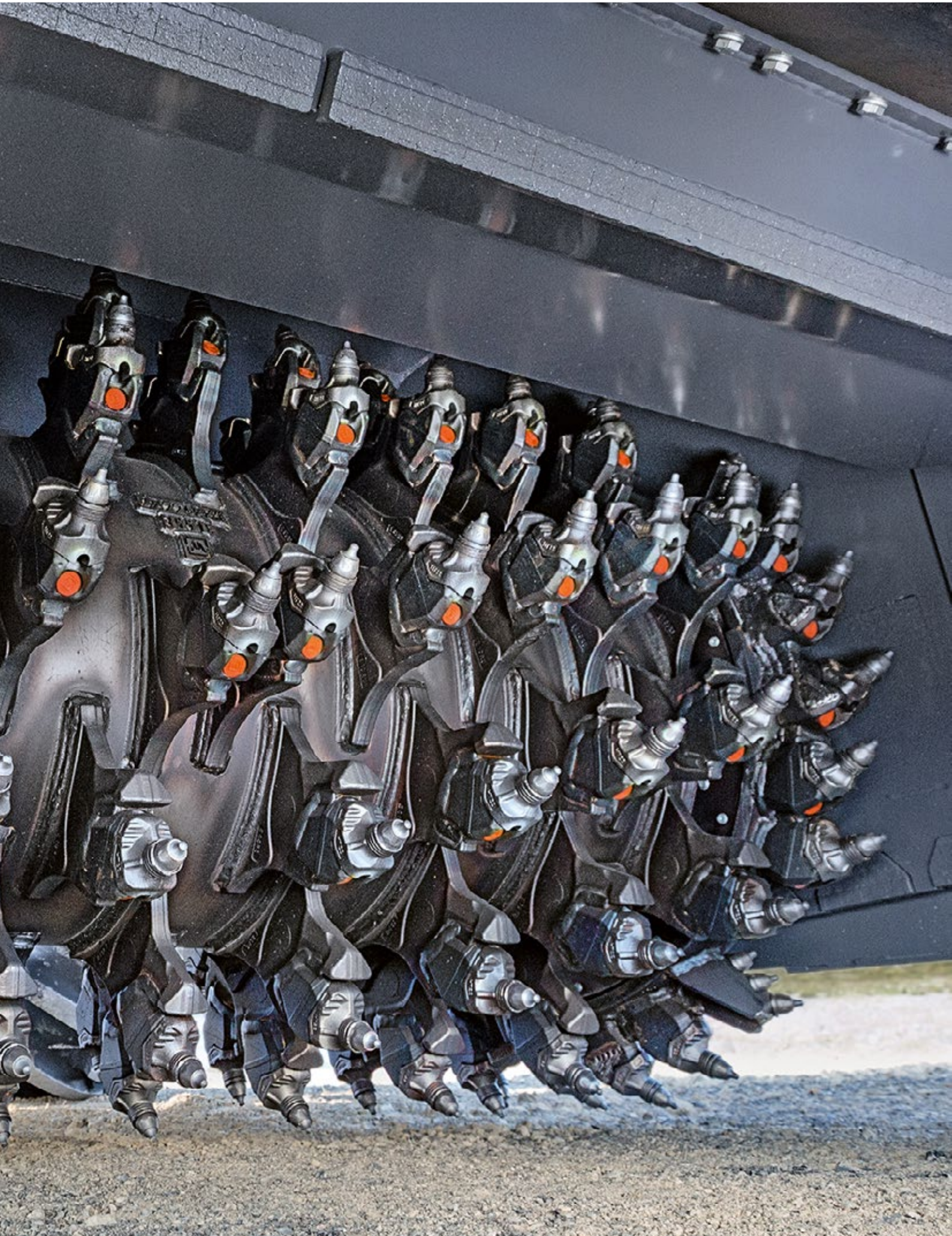

EXCELLENT MILLING AND MIXING PERFORMANCE

Rotor LA 20 for WR 200 (i), WR 240 (i)

Whether soil stabilization or cold recycling is on the agenda, only one milling and mixing rotor is needed to complete all the jobs for the respective machine model. The rotor of the WR 200 (i), WR 240 (i), for example, is fitted with picks arranged at a tool spacing of 20 mm each.

The tooling has been perfectly tailored to the performance of these machine models and represents the ideal solution for all soil stabilization and cold recycling applications. Depending on the job site, pick holders with a shaft diameter of 22 mm or 25 mm can be used.

Rotor LA 30 x 2 for WR 250 (i)

The rotor equipped in the WR 250 (i) has a tool spacing of 30 x 2 mm - two picks per turn are positioned at a tool spacing of 30 mm each. Featuring a large number of picks, the rotor has been perfectly matched to the machine's high performance and advance speed.

Combining high engine power with an extremely robust milling and mixing rotor guarantees outstanding mix quality, even at high machine advance rates. Depending on the job site, pick holders with a shaft diameter of 22 mm or 25 mm can be used.



- 01** The WR 250 (i) equipped with the LA 30 x 2 rotor achieves the exceptionally high production rates required for this operation.
- 02** The intelligent drive design guarantees low fuel consumption and simple maintenance.

Outstanding flexibility

A DURAFORCE mixing rotor for every situation

Maximum Productivity and Efficiency

Mechanical direct drive

Effective Milling Drum Drive

The WR features a direct mechanical drive that translates high engine power into equally high milling and mixing output. Thanks to the large wrap angle with the V-belt pulleys, the heavy-duty power belt transmits the engine power to the milling drum gearbox with minimal power loss, thus ensuring high efficiency. A pleasant side effect of the well-engineered drive concept is its low fuel consumption and easy maintenance.

In addition, nine (WR 200(i), WR 240(i)) and twelve (WR 250(i)) different rotor speeds, respectively, can be selected via the right-hand arm console and the two-stage rotor gearbox in the operator's cabin as well as by repositioning the V-belt pulleys. With the rotor speed set correctly, the WR achieves the desired mixing results at the highest possible advance speed and the lowest possible fuel consumption rate.



EXCELLENT MILLING AND MIXING PERFORMANCE

Outstanding Mixing Quality at Every Working Depth

The rotor housing and rotor plates have been designed to perfectly match the powerful milling and mixing rotor. At the same time, the mixing chamber volume adjusts to the current working depth and material quantity automatically by raising or lowering the rotor. The size of the variable mixing chamber increases with the working depth, thus ensuring maximum performance and outstanding mixing results, even when operating at the maximum depth.

These features enable the machine to produce perfectly homogeneous mixes from the milled material and added binding agents. In addition, the mix is optimally conveyed within the rotor housing, which significantly increases throughput and productivity. The rotor plates at the front and rear are used to seal the mixing chamber, to guide the material, as well as to screed and smooth the deposited layer.

Homogeneous Mixed Material Quality at all Working Depths

Variable mixing chamber

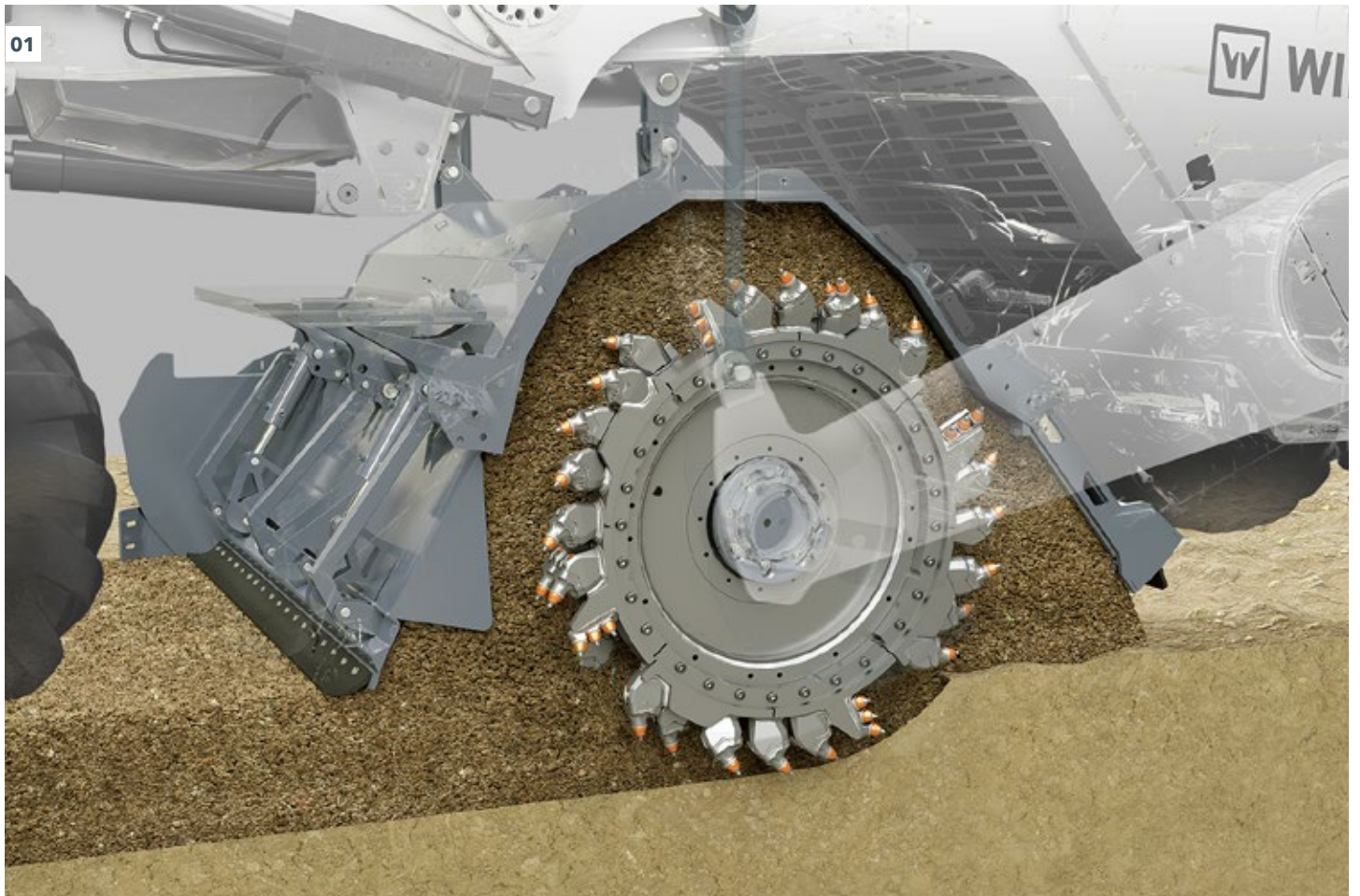



Optimum Mixing Results in All Materials

Variety of rotor speeds,

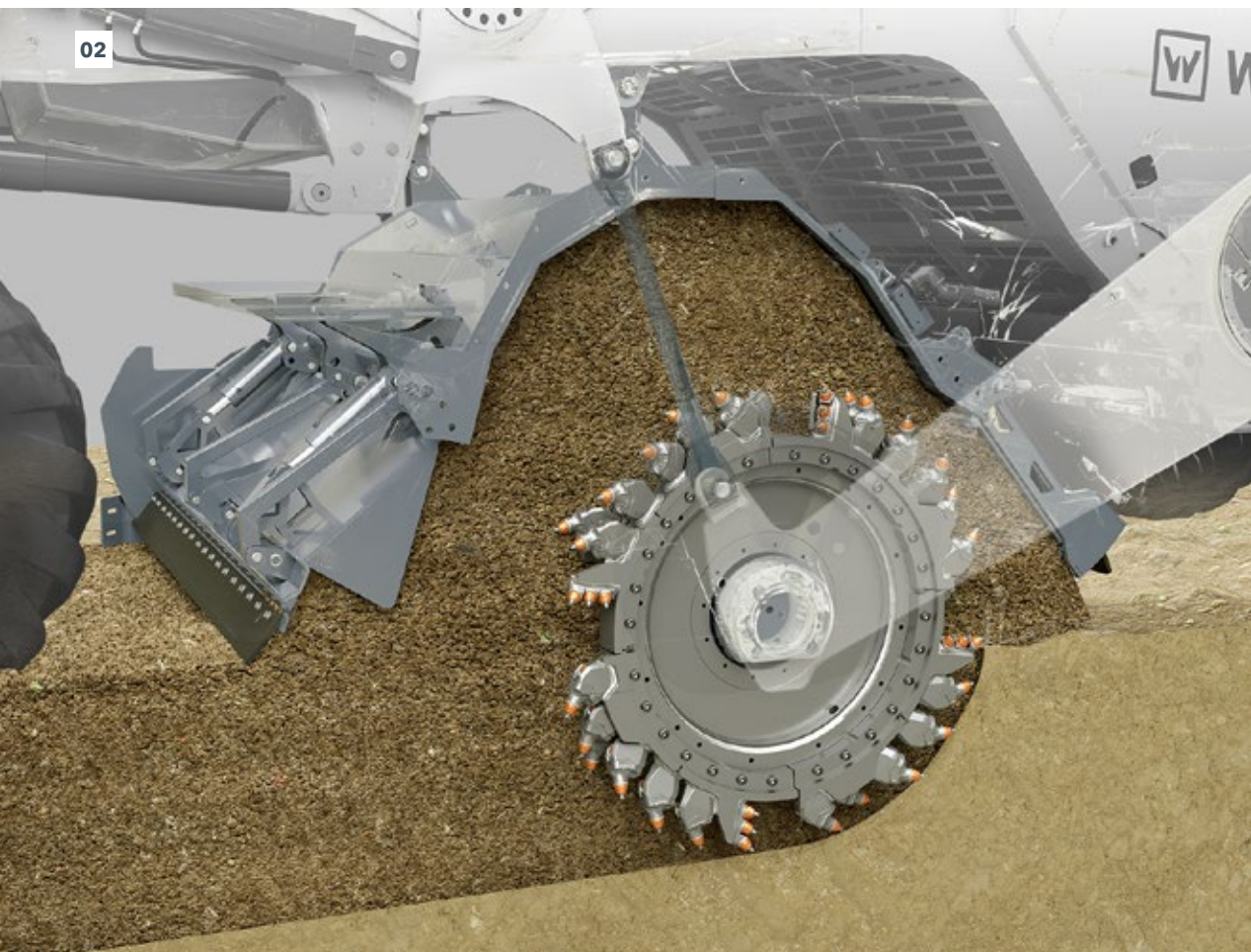

- 01** Small mixing chamber when operating at a shallow working depth with adjustable front crusher bar for crushing even large asphalt blocks.
- 02** Large mixing chamber when operating at a large working depth.
- 03** Homogeneous mix quality, even in tough job site conditions.

HIGH-PRECISION METERING SYSTEMS FOR BINDING AGENTS

01 At a glance: key machine parameters are permanently displayed in the bottom menu bar of the metering menu.

02 The spraying system is controlled via microprocessor and, depending on the recipe, injects water into the mixing chamber in order to achieve the optimum moisture content.

03 Parameters such as the spraying width and amounts of binding agent to be added can be adjusted intuitively.

Microprocessor-Controlled Binding Agent Addition

Simply keying in the specified parameters once is not enough to achieve high-quality mixing results, as they need to be maintained for the entire duration of the operation. The WR has everything it takes to meet this requirements - the parameters can be entered quickly and conveniently via a small number of controls in the left-hand arm console and via the control screen.

Clearly structured, self-explanatory menus allow the operator to quickly access individual pages. Thanks to large, easy-to-understand displays, the operator

is always fully informed of the current parameters during the stabilizing or recycling operation. If specific values require correction, these can be adjusted quickly and effortlessly.

Microprocessor-controlled flowthrough meters regulate the addition of water, bitumen emulsion, or foamed bitumen. The binding agents are added in accordance with the previously specified parameters, such as working width, working depth, material density, and machine advance rate. The injection bars are equipped with up to 16 nozzles, each of which can be activated or deactivated at any time to vary the spraying width.

01

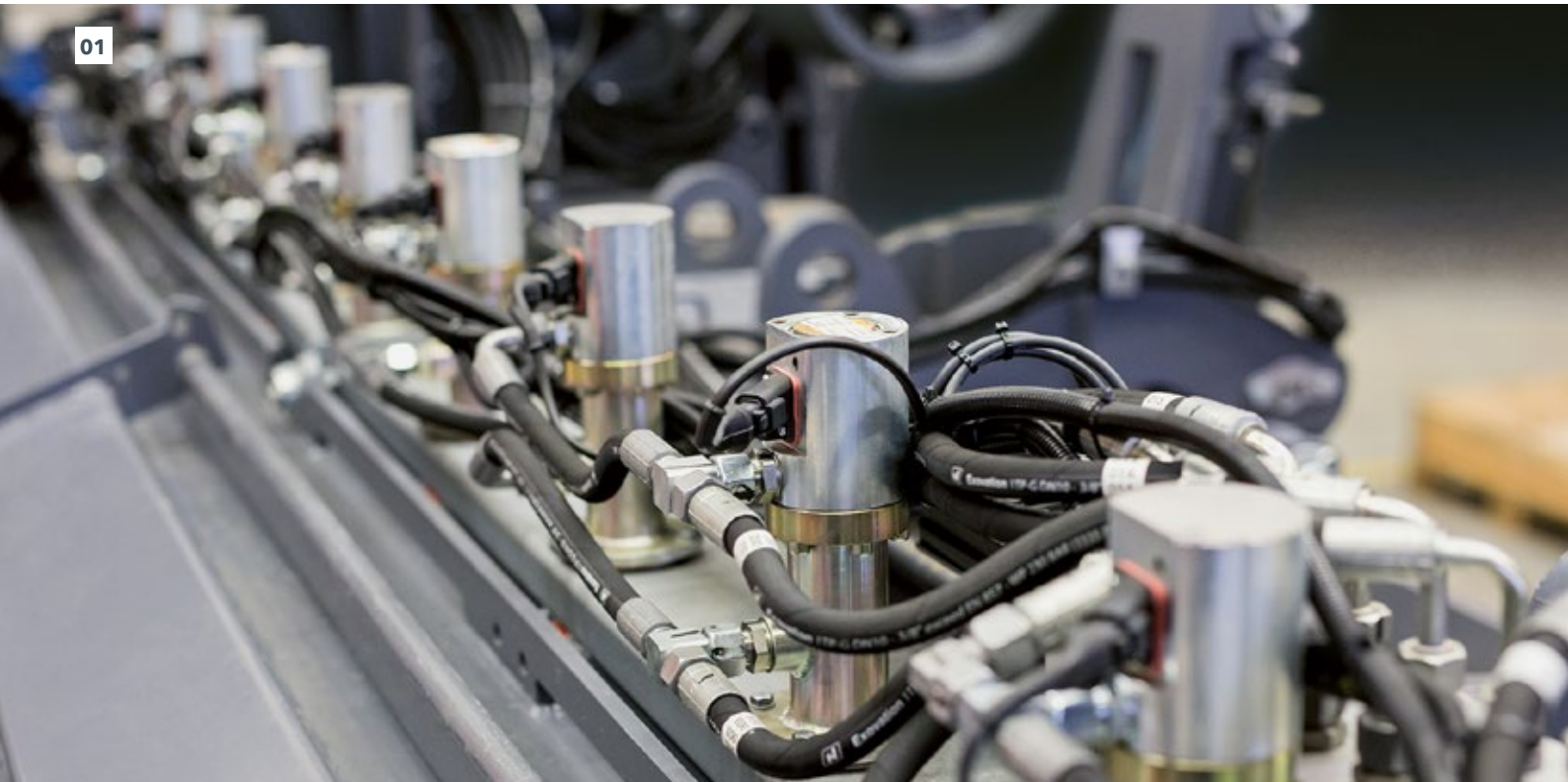

Pinpoint Precision

Microprocessor-controlled addition of binding agents

Perfect Injection Pressure

VARIO injection bars

Adjustable Injection Pressure

The **VARIO** injection bars for foamed bitumen, emulsion, and water feature nozzles with an adjustable outlet cross-section that enables flexible adjustment of the injection pressure. This allows the spray jet to penetrate deeper into the milled material and achieve optimal spray width distribution. The spray width can also be individually adjusted.



Low spraying volume

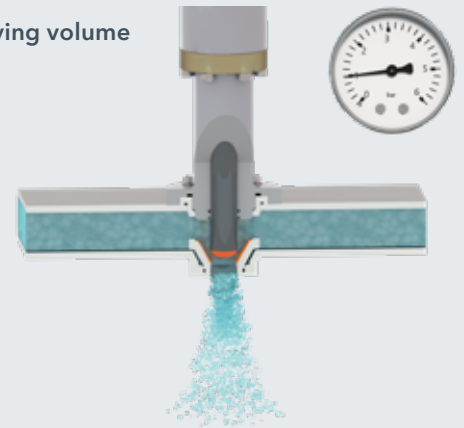

High spraying volume

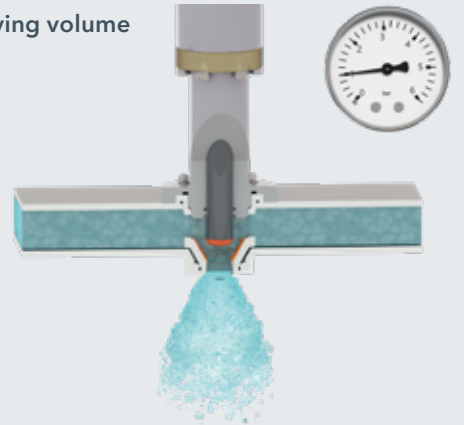

Cleaning - e.g. manual pricking

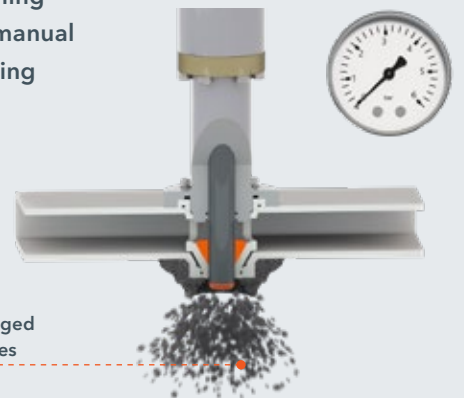

Dislodged residues

Functional principle: variable nozzle cross-section of the injection bar for water or bitumen emulsion.

HIGH-PRECISION METERING SYSTEMS FOR BINDING AGENTS

Injecting Water

Strictly adhering to the specified dosage of binding agents is imperative for high-quality stabilization and recycling processes. The WR is fully equipped to meet this requirement - heavy-duty, microprocessor-controlled spraying systems can be relied on to precisely regulate the addition of water, bitumen emulsion, or foamed bitumen.

Depending on the application, several injection bars can be installed and different binding agents can be added at the same time. In addition, a special quick-mounting feature enables the injection bars to be installed or removed quickly and effortlessly.



01 All of the hose connections are attached to the front cross member.

Ideal Moisture Content

Precise water metering

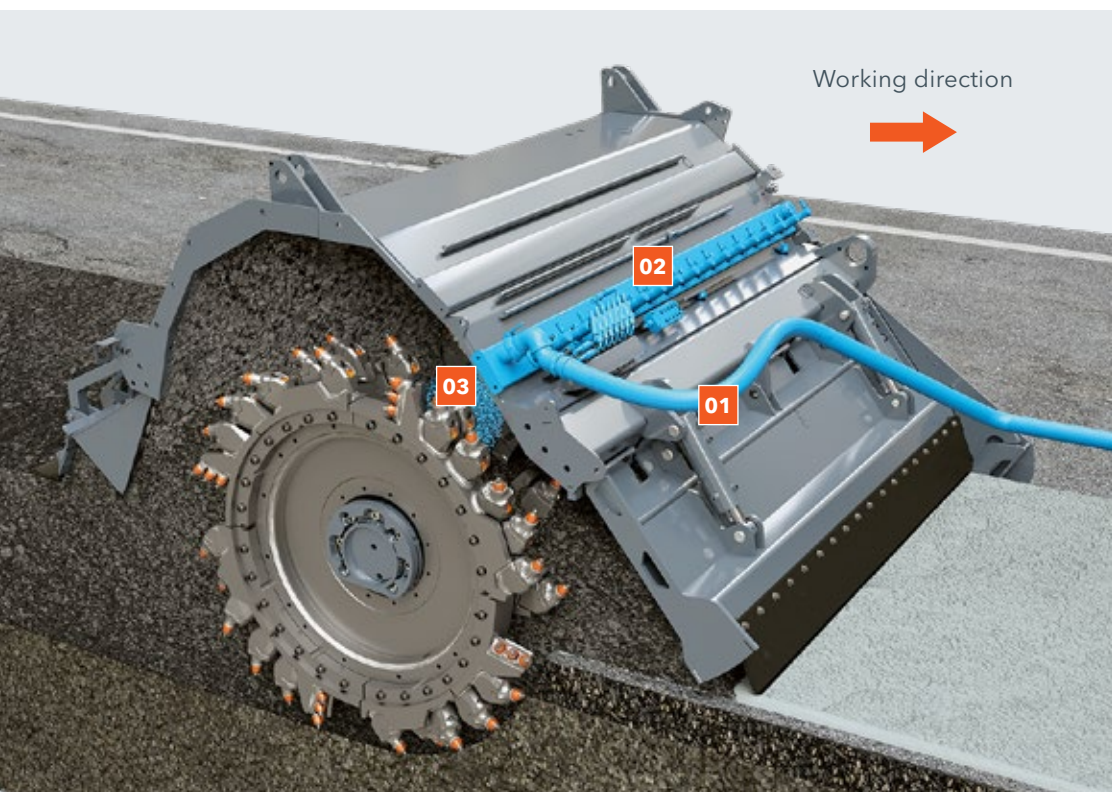

- 01 Water supply hose
- 02 Injection bar for water
- 03 Sprayed-in water

Controlled by a microprocessor, the injection bar sprays the required amount of water into the mixing chamber.

Injecting Water and Bitumen Emulsion

Water and emulsion are supplied to the injection bars via hose lines connected to tankers driving ahead of the machine. The microprocessor-controlled injection bars for water and emulsion are identical and can be used for both substances depending on the application.

The binding agent bitumen emulsion increases the flexibility of the new base layer and reduces cracking. The optimum moisture content is achieved by simultaneously adding water to the process.



02 Connections for water and emulsion are easily accessible.

For a Flexible Base Layer

Bitumen emulsion

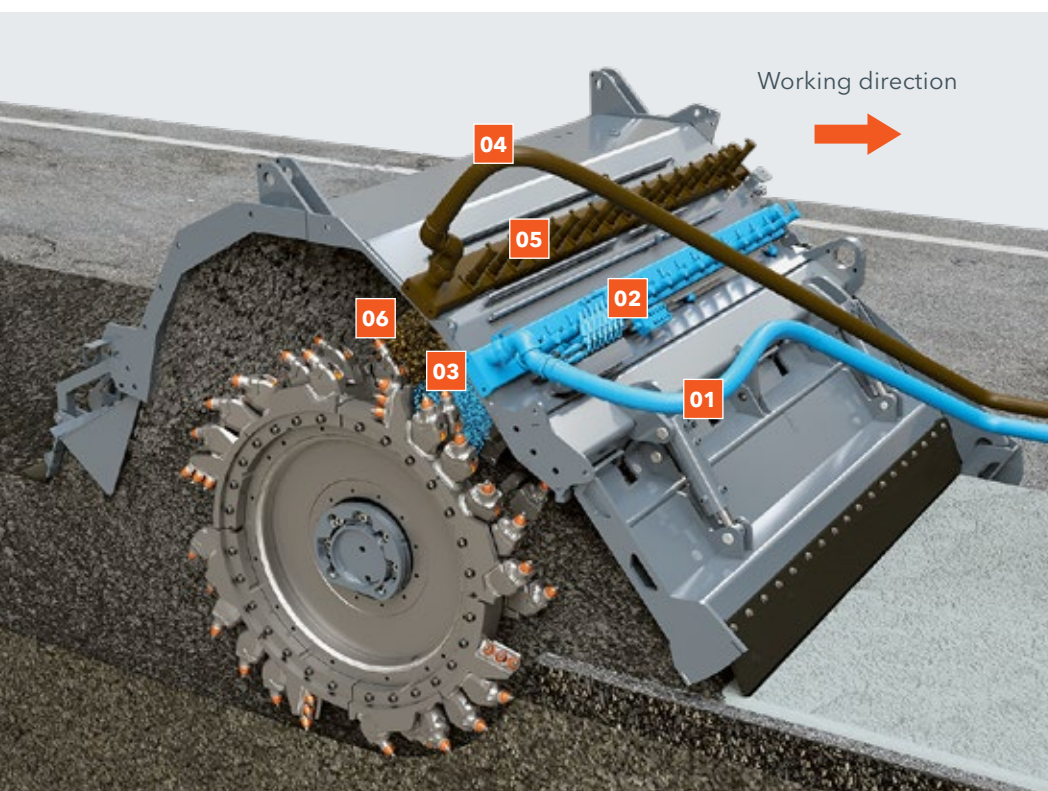

- 01 Water supply hose
- 02 Injection bar for water
- 03 Sprayed-in water
- 04 Emulsion supply hose
- 05 Injection bar for emulsion
- 06 Sprayed-in emulsion

When adding both water and emulsion, two injection bars can be operated simultaneously.

HIGH-PRECISION METERING SYSTEMS FOR BINDING AGENTS

Injecting Water and Foamed Bitumen

For base layers of exceptionally high quality, the WR produces foamed bitumen in up to sixteen separate expansion chambers by injecting small amounts of water and compressed air into hot bitumen at a temperature of approx. 180° C. The hot bitumen then foams abruptly, expanding to many times its original volume. In this state, the foamed bitumen spreads particularly evenly in the granulated aggregate mix. All the components that convey hot bitumen are heated and kept at the required operating temperature - eliminating the need to flush the system. All in all, foamed bitumen is a very cost-effective binding agent.

The easily accessible test nozzle makes it easy to continuously monitor foam quality during operation.



01 The filling connector for foamed bitumen is easily accessible.

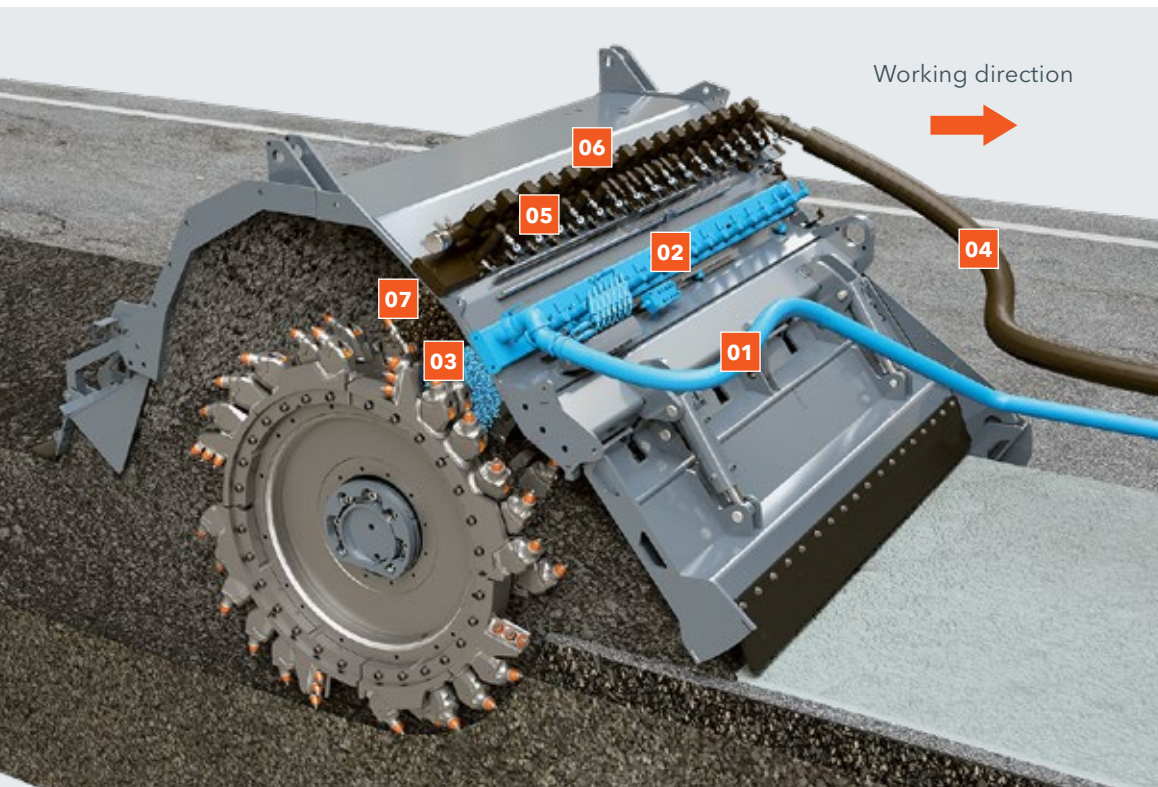

- 01 Water supply hose
- 02 Injection bar for water
- 03 Sprayed-in water
- 04 Supply hose for hot bitumen
- 05 Injection bar for foamed bitumen
- 06 Expansion chambers for the foaming process
- 07 Sprayed-in foamed bitumen

The microprocessor-controlled injection bar sprays foamed bitumen into the mixing chamber in precisely metered quantities.

Automatic Cleaning Processes

Individual nozzles are regularly closed at short intervals as the work progresses. The sudden rise in pressure then cleans the open nozzles on the VARIO injection bars.

Alternatively, the nozzles can be cleaned by pushing the hydraulic cylinder through the nozzle outlet to remove residues when the work is interrupted or finished.



Efficient - and Available Around the World
Foamed bitumen

Uninterrupted Working
Automatic self-cleaning function

HIGH-PRECISION METERING SYSTEMS FOR BINDING AGENTS

Built-In Binding Agent Spreader

The "S-Pack" (short for "spreader pack") binding agent spreader optionally built into the WR 240(i) or WR 250(i) is used for dust-free spreading of binding agents in cold recycling and soil stabilization. It spreads lime or cement right in front of the milling and mixing rotor in a microprocessor-controlled operation. "S-Pack" is synonymous with the reliable and dustless spreading of binding agents, especially on highways, in industrial areas with strict emission requirements, residential areas, or nature reserves. Bindemitteln.

The "S-Pack" spreader can be loaded to capacity in less than five minutes. A standard 27-ton silo transporter can be emptied within two hours. The spreading process is controlled and monitored intuitively via the built-in control screen.

The excellent off-road capability of the WR series means that binding agents can now be safely and precisely spread even on terrain with low bearing capacity.



01 Binding agents can be spread with pinpoint precision and almost completely dust-free, regardless of wind and weather conditions.

02 Filling the container with binding agent only takes a few minutes.



01 Inspection opening

02 Binder container

03 Sensors

04 Filler port with shut-off cock

05 Conveying unit

06 Transverse auger conveyor

07 Closable flap

08 Metering cells

09 Dust protection

10 Exhaust filter system

02



Low Dust Emissions When Adding Binding Agents
Integrated "S-Pack"

The WR series' range of applications includes soil treatment, consolidation in road construction, and cold recycling of asphalt roads.

The Compact Machine – The WR 200(i) stands out thanks to its compact dimensions and reduced weight – this usually means it can be transported without a special permit.

The Multipurpose Machine – The WR 240(i) is ideal for challenging tasks with increased power requirements.

The Powerful Machine – The WR 250(i) is the high-performance machine in the WR series, designed to meet the greatest challenges.

TECHNICAL SPECIFICATIONS	WR 200	WR 200 i	WR 200 i
Exhaust emission standard	EU Stage 3a / US EPA Tier 3	EU Stage 4 / US EPA Tier 4f	EU Stage 5 / US EPA Tier 4f
Milling and Mixing Rotor			
Working width	2,000 mm		
Working depth ¹⁾	0 - 500 mm		
Tool spacing	20 mm		
Number of tools	150		
Cutting diameter	1,480 mm		
Engine			
Engine manufacturer	Mercedes Benz	Mercedes Benz / MTU	
Type	OM 460 LA	OM 470 LA / 6R 1100	
Number of cylinders	6		
Power	at 2,000 rpm: 305 kW / 409 HP / 415 PS	at 1,900 rpm: 308 kW / 412 HP / 418 PS	at 1,900 rpm: 316 kW / 421 HP / 430 PS
Maximum power	at 1,800 rpm: 315 kW / 422 HP / 428 PS	at 1,700 rpm: 320 kW / 429 HP / 435 PS	at 1,600 rpm: 320 kW / 429 HP / 435 PS
Displacement	12.8 l	10.7 l	
Fuel consumption, full load during mixture of job site operations	80 l/h 39 l/h	75 l/h 35 l/h	
Sound power level in accordance with EN 500-3 Motor operator's platform	≤106 dB(A) ≥70 dB(A)	≤106 dB(A) ≥70 dB(A)	
Electrical System			
Power supply	24 V		
Tank Capacities			
Fuel tank	830 l		
Fuel tank when equipped with optional "S-Pack"	-		
AdBlue® / DEF ²⁾	-	80 l	
Hydraulic oil tank	200 l		
Binder container "S-Pack"	-		
Water tank	380 l		
Additional water tank	-		
Driving Performance			
Operating speed in milling and travel gear	0 - 210 m/min (12.6 km/h)		
Max. cross slope	8°		
Ground clearance	approx. 400 mm		
Tires			
Tire size, front / rear	620 / 75 R26		
Transport Dimensions			
Dimensions for truck transport (L x B x H)	9,160 x 2,550 x 3,000 mm		
Dimensions for truck transport with optional "S-Pack" (L x B x H)	-		

¹⁾ The maximum working depth may deviate from the value indicated due to tolerances and wear

²⁾ AdBlue® is a registered trademark of the German Association of the Automotive Industry (VDA)



	WR 240	WR 240 i	WR 250	WR 250 i
	EU Stage 3a / US EPA Tier 3	EU Stage 5 / US EPA Tier 4f / CN NR Stage 4	EU not rated / US EPA Tier 2	EU Stage 5 / US EPA Tier 4f
	2,400 mm		2,400 mm	
	0 - 510 mm		0 - 560 mm	
	20 mm		30 mm x 2	
	170		208	
	1,480 mm		1,480 mm	
	Cummins		Caterpillar	
	QSX 15	X-15	C18 ATAAC	
	6		6	
	at 2,100 rpm: 447 kW / 600 HP / 608 PS		at 2,100 rpm: 571 kW / 766 HP / 777 PS	at 1,950 rpm: 563 kW / 755 HP / 766 PS
	at 1,900 rpm: 455 kW / 610 HP / 619 PS		at 1,800 rpm: 571 kW / 766 HP / 777 PS	at 1,700 rpm: 563 kW / 755 HP / 766 PS
	15.0 l	14.9 l	18.1 l	18.1 l
	120 l/h 60 l/h	115 l/h 55 l/h	142 l/h 70 l/h	147 l/h 72 l/h
	≤110 dB(A) ≥76 dB(A)	≤109 dB(A) ≥72 dB(A)	≤111 dB(A) ≥78 dB(A)	≤112 dB(A) ≥74 dB(A)
	24 V			
	1,500 l	1,380 l	1,500 l	
	1,300 l	1,180 l	1,300 l	
	-	100 l	-	
	320 l			
	5.5 m ³			
	500 l			
	950 l			
	0 - 210 m/min (12.6 km/h)			
	8°			
	approx. 400 mm			
	28L - 26			
	9,230 x 3,000 x 3,000 mm			
	9,680 x 3,000 x 3,080 mm			

TECHNICAL SPECIFICATIONS	WR 200	WR 200 i
Weight of Basic Machine		
Empty weight of machine with standard equipment without fluids	23,500 kg	23,800 kg
Operating weight, CE ¹⁾	24,200 kg	24,500 kg
Maximum operating weight (full tanks, full range of equipment)	26,500 kg	26,800 kg
Weight of Tank Contents		
Water	380 kg	
Additional water tank	-	
Fuel (0.83 kg/l)	690 kg	
Fuel (0.83 kg/l) when equipped with optional "S-Pack"	-	
AdBlue® / DEF ²⁾	-	80 kg
Binding agent (S-Pack)	-	
Additional Weight		
Operator and Tools		
> Machine operator	75 kg	
> 5 pick buckets	125 kg	
Injection system instead of standard		
> Single ESL: Injection system for water or bitumen emulsion	450 kg	
> Dual ESL: Injection system for water and bitumen emulsion	760 kg	
> ESL foamed bitumen: Injection system for water and foamed bitumen	1,310 kg	
> ESL 1800 L: Injection system for water up to 1,800 l/min	410 kg	
> Built-in binding agent spreader (S-Pack) with exhaust filter	-	
Optional Additional Equipment		
> Additional water tank (empty)	-	

¹⁾ Machine weight, half-full tanks, vehicle tool kits, machine operator, excluding optional equipment

²⁾ AdBlue® is a registered trademark of the German Association of the Automotive Industry (VDA)

	WR 240	WR 240 i	WR 250	WR 250 i
	29,000 kg	29,600 kg	30,750 kg	31,050 kg
	30,000 kg	30,600 kg	31,700 kg	32,000 kg
	40,400 kg	41,000 kg	43,100 kg	43,400 kg
			500 kg	
			950 kg	
	1,245 kg	1,145 kg		1,245 kg
	1,070 kg	970 kg		1,070 kg
	-	100 kg		-
			5,000 kg	
			75 kg	
			125 kg	
			390 kg	
			720 kg	
			1,400 kg	
			390 kg	
			3,800 kg	
			420 kg	

SIDE VIEW / TOP VIEW WR 200 (i)

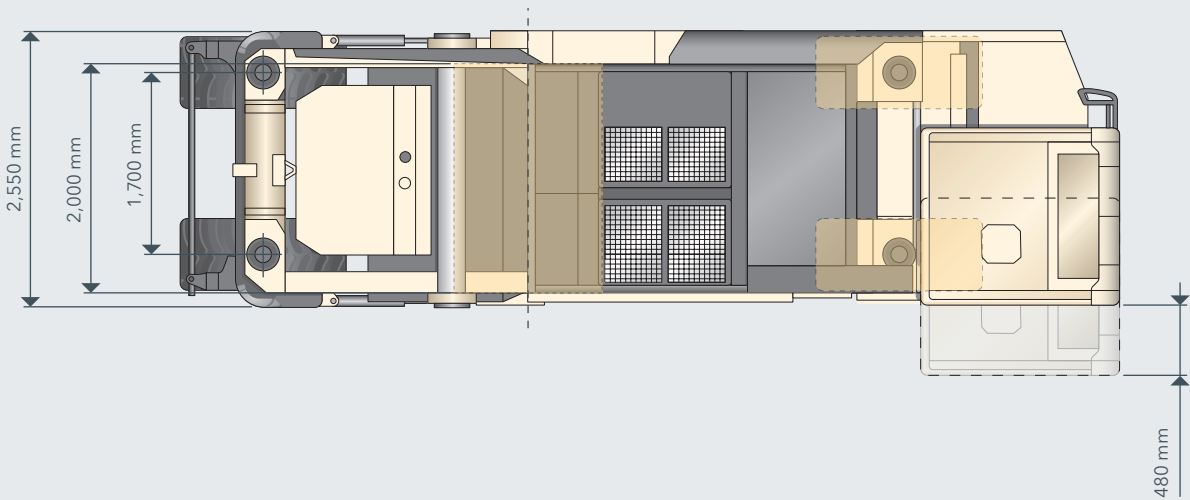
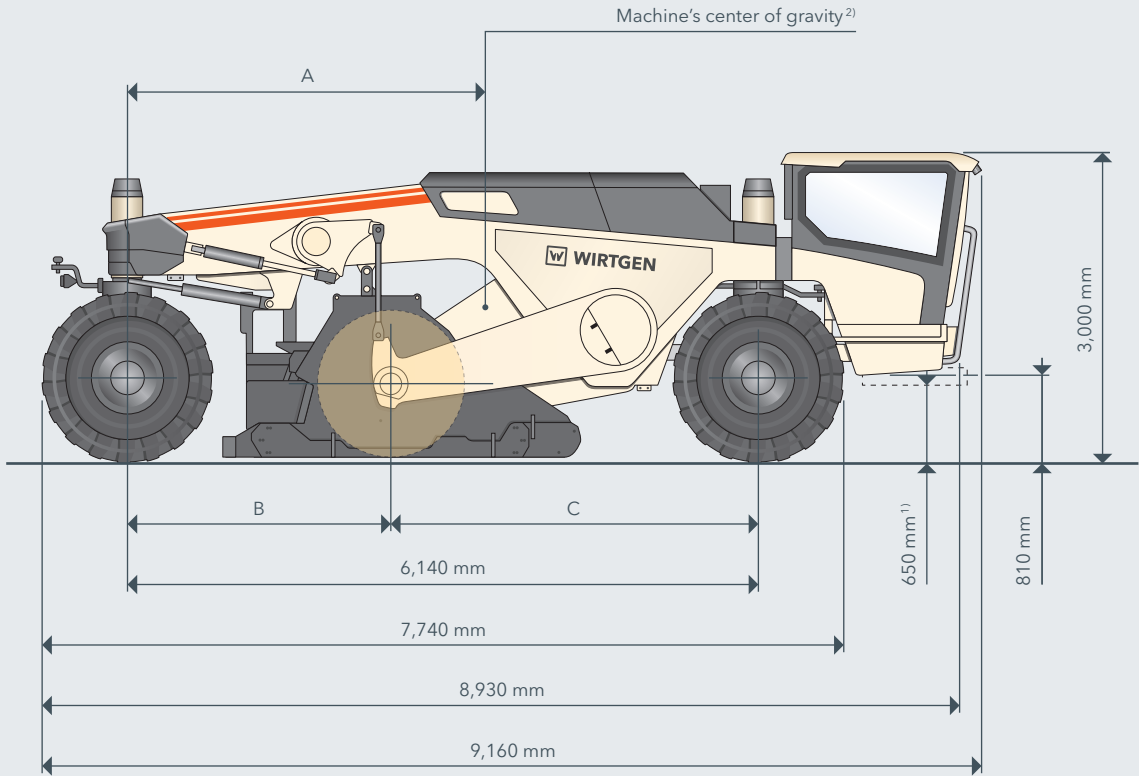

¹⁾ with injection system

²⁾ based on operating weight, CE

	A	B	C
WR 200 (i)	3,470 mm	2,540 mm	3,600 mm

SIDE VIEW / TOP VIEW WR 240(i) AND WR 250(i)

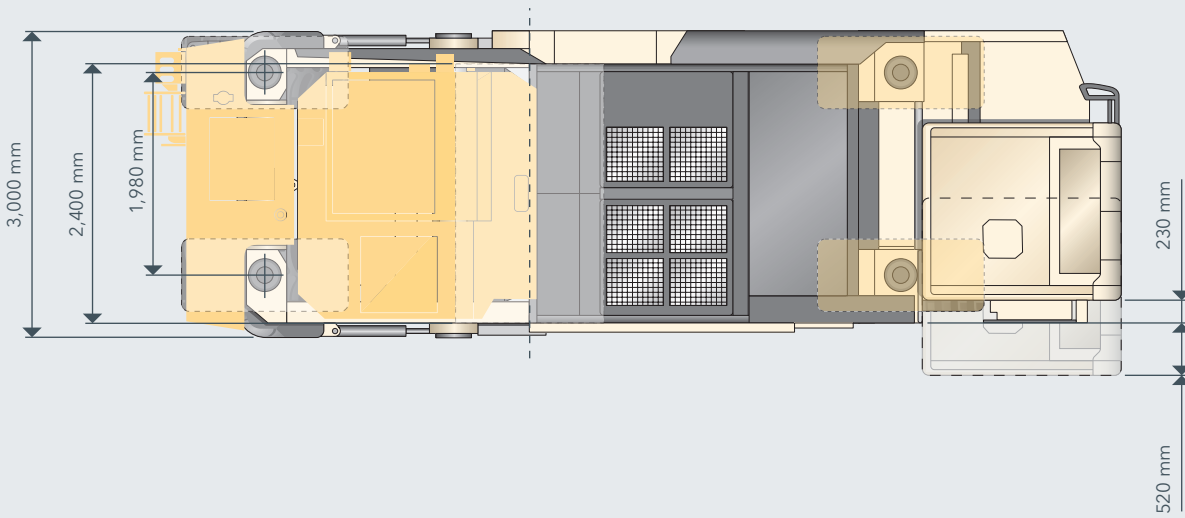
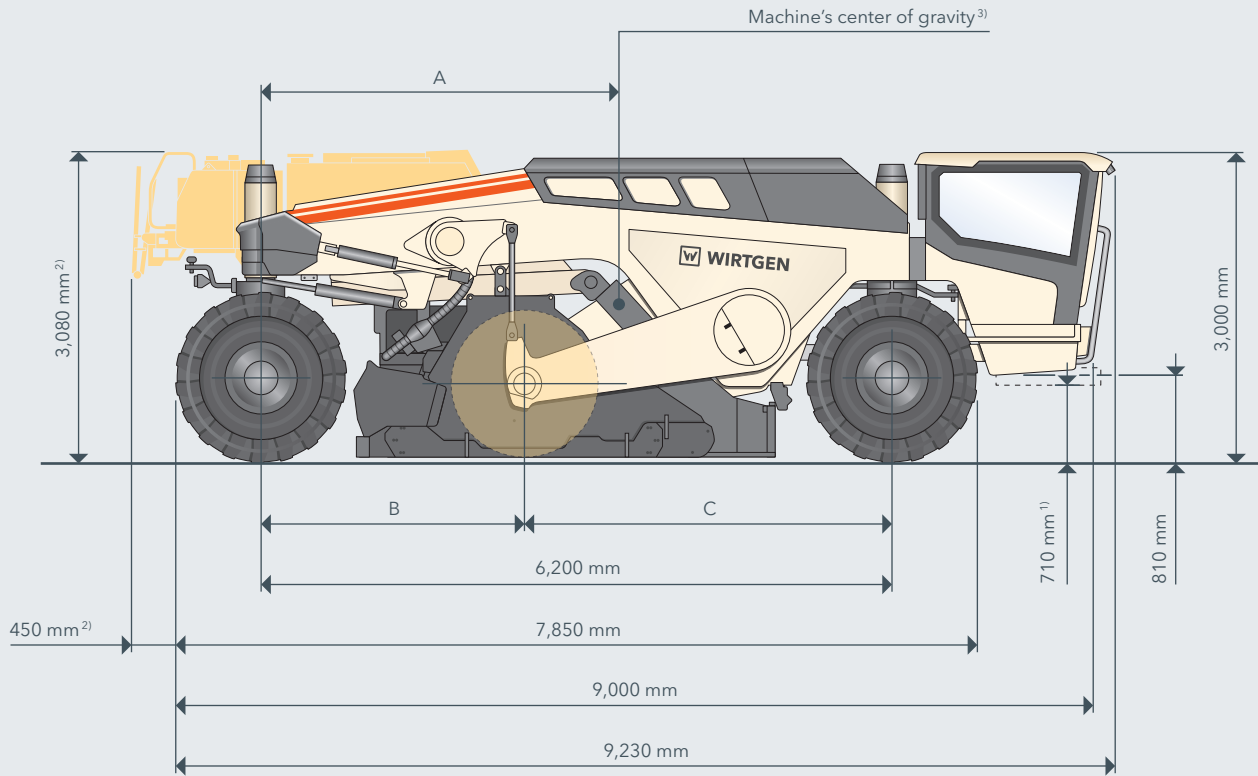

¹⁾ with injection system
²⁾ with S-Pack
³⁾ based on operating weight, CE

	A	B	C
WR 240(i)	3,550 mm	2,600 mm	3,600 mm
WR 250(i)	3,500 mm	2,550 mm	3,650 mm

TURNING RADIUS WR 200(i), WR 240(i) AND WR 250(i)

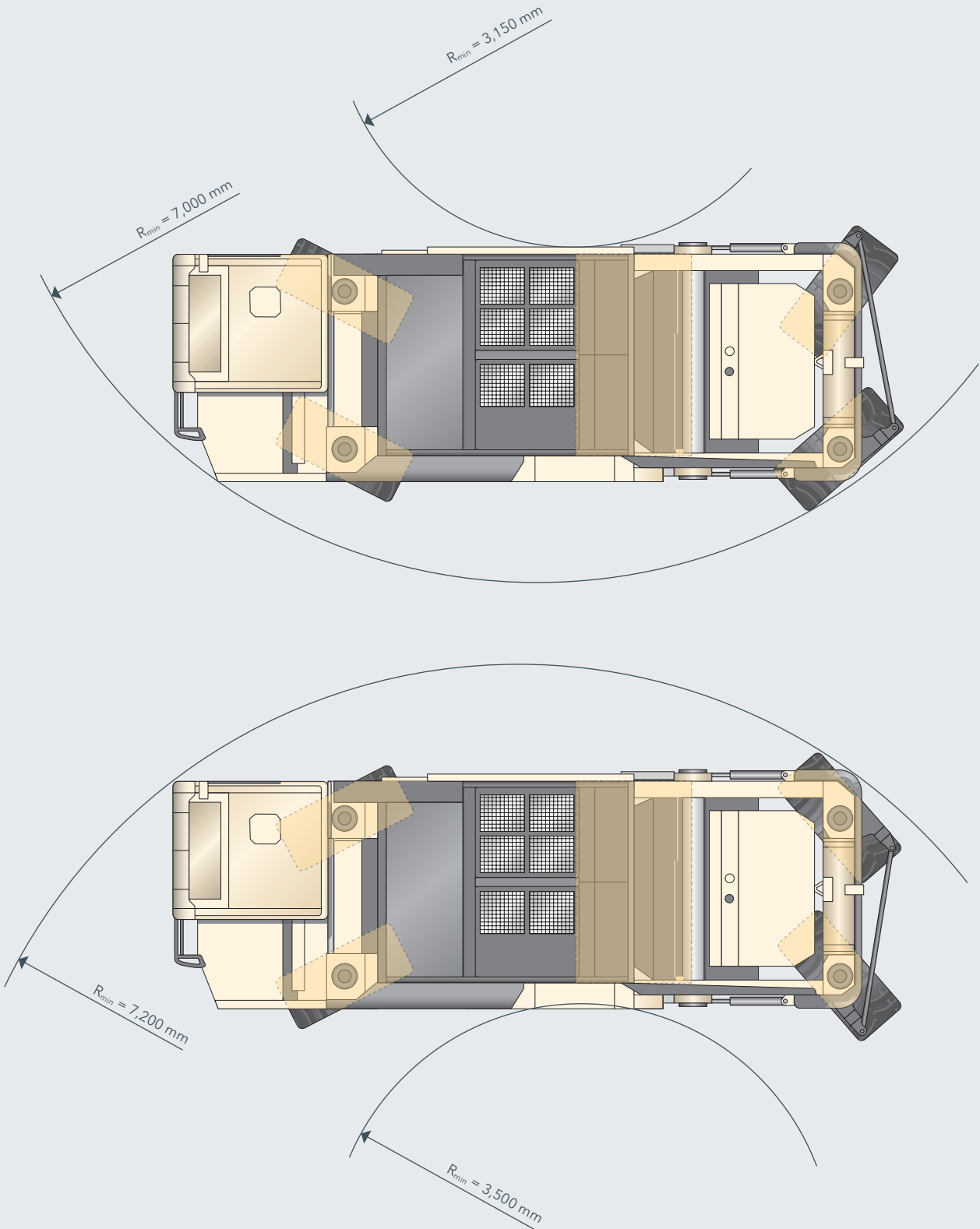



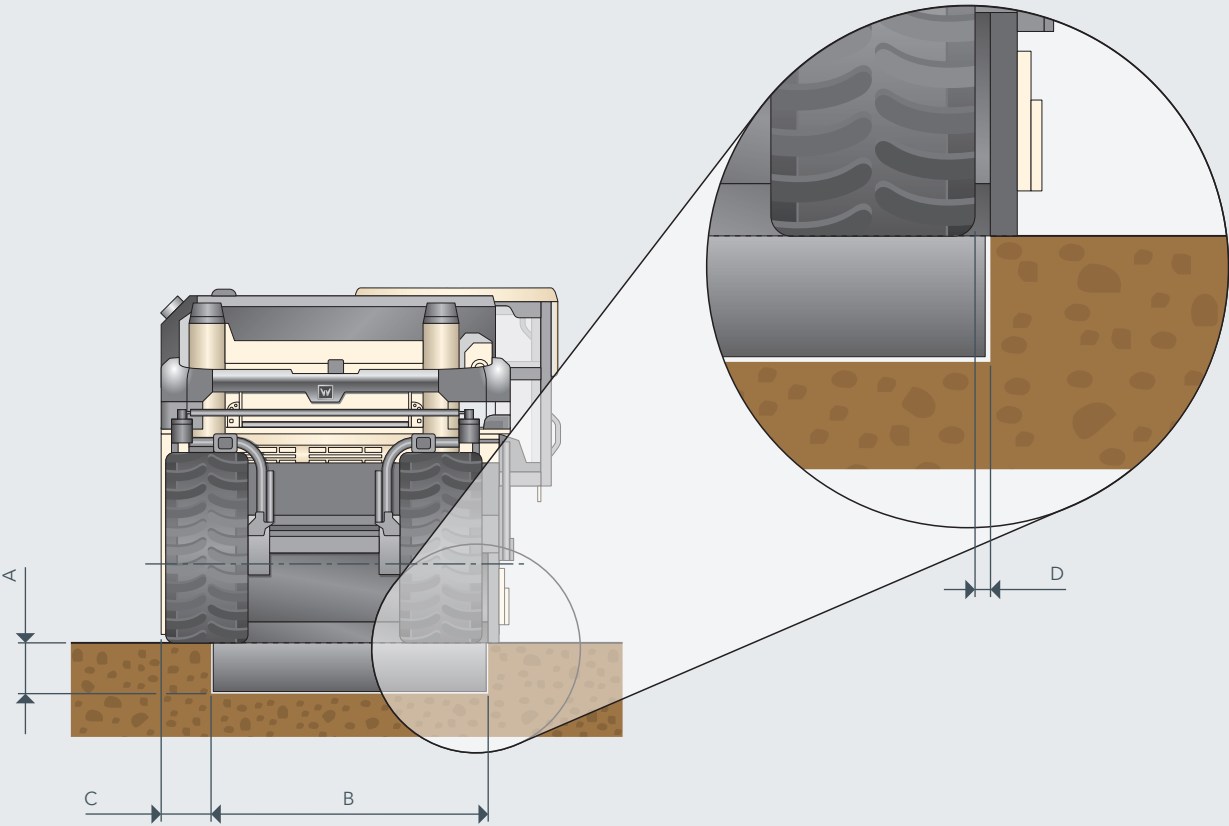



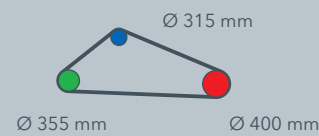
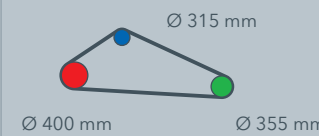
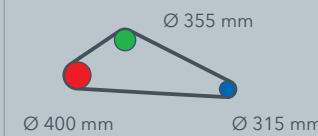

REAR VIEW WR 200(i), WR 240(i) AND WR 250(i)



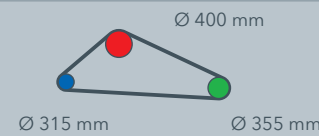
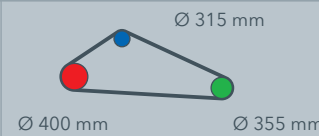
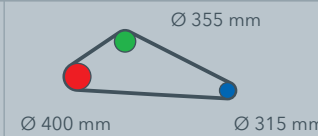















	A	B	C	D
WR 200(i)	500 mm	2,000 mm	370 mm	approx. 25 mm
WR 240(i)	510 mm	2,400 mm	420 mm	approx. 50 mm
WR 250(i)	560 mm	2,400 mm	420 mm	approx. 50 mm

MILLING DRUM SPEED WR 200 (i), WR 240 (i)*)

WR 200 (i)	Engine Speed			
		108 rpm	137 rpm	154 rpm
		117 rpm	149 rpm	168 rpm
		127 rpm	161 rpm	181 rpm
WR 240 (i)	Engine Speed			
		108 rpm	137 rpm	154 rpm
		120 rpm	153 rpm	172 rpm
		133 rpm	169 rpm	190 rpm

*) The milling drum speed depends on the selected diesel engine speed

MILLING DRUM SPEED WR 250(i)*)

WR 250 (i)	Gear shift Milling drum gearbox	Engine Speed	 Ø 355 mm Ø 400 mm	 Ø 400 mm Ø 355 mm	
	 	 		87 rpm	111 rpm
			97 rpm	124 rpm	
			108 rpm	137 rpm	
 		 		129 rpm	164 rpm
				145 rpm	184 rpm
				160 rpm	203 rpm

*) The milling drum speed depends on the selected diesel engine speed

STANDARD EQUIPMENT	WR 200	WR 200 i	WR 240	WR 240 i	WR 250	WR 250 i
Basic Machine						
> Base machine with engine	■	■	■	■	■	■
> Machine chassis with built-in water tank and clear view of the right milled edge	■	■	■	■	■	■
> The right wheels are positioned within the milling width for working flush with the edge	■	■	■	■	■	■
> Diesel engine power controller for optimum milling and mixing results	■	■	■	■	■	■
> Engine cooling system with temperature-controlled fan speed	■	■	■	■	■	■
> Air compressor system max. 8 bar	■	■	■	■	■	■
> Lockable engine cover with built-in sound insulation package	■	■	■	■	■	■
> Mechanical milling drum drive via a drive belt with automatic belt tensioner	■	■	■	■	■	■
> Variable cutting speed by combination of 3 selectable engine speeds and 3 adjustable drive belt pulley arrangements to achieve optimum working results	■	■	■	■	—	—
> Variable cutting speed by a combination of 3 selectable motor speeds, 2 variable drive belt pulley arrangements and one milling drum gearbox with 2-gear stages for achieving optimum working results	—	—	—	—	■	■
> Synchronous rotation or counter-rotating mode possible, depending on working direction	■	■	■	■	■	■
> Hydraulically adjustable milling drum flap in front of the drum	■	■	■	■	■	■
> Hydraulically adjustable scraper plates behind the drum	■	■	■	■	■	■
> Infinitely variable working depth adjustment by lowering or raising the entire milling drum	■	■	■	■	■	■
> Automatic mixing chamber adjustment to the respective working depth (larger mixing chamber for lower working depths)	■	■	■	■	■	■
> Milling drum rotation device with hydraulic milling drum drive for slowly turning the milling drum in the pick change	—	—	—	—	■	■
> Power-controlled lowering speed of the milling drum in starting mode	■	■	■	■	■	■
Milling and Mixing Unit						
> Standard FB2400 milling drum housing	—	—	—	—	■	■
Milling and Mixing Rotor						
> Milling and mixing rotor FB2000 HT5 LA20 D22 with 150 picks	■	■	—	—	—	—
> DURAFORCE milling and mixing rotor FB2400 HT22 LA20 D22 with 170 picks	—	—	■	■	—	—
> DURAFORCE milling and mixing rotor FB2400 HT22 LA30x2 D22 with 208 picks	—	—	—	—	■	■
Injection System / Addition of Binders						
> Model without spraying system	■	■	■	■	■	■
> Model without binder spreader device	—	—	■	■	■	■
Machine Control and Leveling System						
> Multifunctional color control display that shows important machine operating conditions	■	■	■	■	■	■
> Comprehensive machine diagnostics displayed on the control screen	■	■	■	■	■	■
> Programmable automatic system for initiating and completing the milling process at the particular working depth	■	■	■	■	■	■
> Automated features to reduce the machine operator's workload	■	■	■	■	■	■

STANDARD EQUIPMENT	WR 200	WR 200 i	WR 240	WR 240 i	WR 250	WR 250 i
Operator's Platform						
> Comfortable, high-quality cabin with flexible mountings, with roof hatch and individually adjustable heating	■	■	■	■	■	■
> Ergonomic, air-cushioned operator's seat	■	■	■	■	■	■
> Roll-over protection system (ROPS and FOPS) integrated in the cab frame	■	■	■	■	■	■
> Large windows with an excellent view of the respective work area and built-in windshield wipers	■	■	■	■	■	■
> Recirculating and fresh air filters can be changed without tools	■	■	■	■	■	■
> Various shelves and storage compartments as well as 12 V and 24 V sockets	■	■	■	■	■	■
> In order to provide an ideal view over the zero edge, the operator's cabin can be shifted over the right-hand side of the machine	■	■	■	■	■	■
> Rotation of the operator's platform through 90° offers optimum adaptation to the particular working situation	■	■	■	■	■	■
> Individually adjustable control panel with color display	■	■	■	■	■	■
> Reversing camera with graphical reversing assistant	■	■	■	■	■	■
> Mirrors on right and left in the front area of the machine	■	■	■	■	■	■
> Working lights integrated into the cabin roof	■	■	■	■	■	■
> Folding ladder to access the operator's platform	—	—	■	■	■	■
Track Unit and Height Adjustment						
> Infinitely adjustable, hydraulic all-wheel drive	■	■	■	■	■	■
> Four-way tilting of the lifting columns to compensate for uneven terrain	■	■	■	■	■	■
> Electrohydraulic, light all-wheel steering, with the "crab", "cornering" or "straight ahead" steering types	■	■	■	■	■	■
Misceallaneous						
> "Welcome-and-Go-Home-Light" with LED lighting in the ladder area	■	■	■	■	■	■
> Extensive safety package with 3 EMERGENCY STOP switches	■	■	■	■	■	■
> Large tool kit in lockable tool box	■	■	■	■	■	■
> Pre-fitting for installing the WITOS FleetView control unit	■	■	■	■	■	■
> European type certification, EuroTest mark and CE conformity	■	■	■	■	■	■
> Standard painting in RAL 9001 (cream)	□	□	□	□	□	□
> WITOS - professional telematics solution for optimizing machine usage and servicing for WPT	□	□	□	□	□	□
> Pre-fitting fo WIRTGEN PERFORMANCE TRACKER and AutoTrac™	—	□	—	□	—	□
> Halogen lighting package, 24 V, including rotating beacon	□	□	□	□	□	□
> Model without waste air filtering	—	—	□	□	□	□

■ = Standard equipment

□ = Standard equipment, can be replaced with optional equipment if desired

— = Optional equipment

OPTIONAL EQUIPMENT	WR 200	WR 200 i	WR 240	WR 240 i	WR 250	WR 250 i
Miscellaneous						
> Painting in one special color (RAL)	<input type="checkbox"/>	<input type="checkbox"/>	<input type="checkbox"/>	<input type="checkbox"/>	<input type="checkbox"/>	<input type="checkbox"/>
> Painting in two special colors (RAL)	<input type="checkbox"/>	<input type="checkbox"/>	<input type="checkbox"/>	<input type="checkbox"/>	<input type="checkbox"/>	<input type="checkbox"/>
> Model without WITOS	<input type="checkbox"/>	<input type="checkbox"/>	<input type="checkbox"/>	<input type="checkbox"/>	<input type="checkbox"/>	<input type="checkbox"/>
> High-performance LED lighting package with patrol lights	<input type="checkbox"/>	<input type="checkbox"/>	<input type="checkbox"/>	<input type="checkbox"/>	<input type="checkbox"/>	<input type="checkbox"/>
> Manual waste air filtering S-Pack	—	—	<input type="checkbox"/>	<input type="checkbox"/>	<input type="checkbox"/>	<input type="checkbox"/>
> Automatic waste air filtering S-Pack	—	—	<input type="checkbox"/>	<input type="checkbox"/>	<input type="checkbox"/>	<input type="checkbox"/>
> Printer for recording the job data	<input type="checkbox"/>	<input type="checkbox"/>	<input type="checkbox"/>	<input type="checkbox"/>	<input type="checkbox"/>	<input type="checkbox"/>
> USB interface for retrieving the job data	<input type="checkbox"/>	<input type="checkbox"/>	<input type="checkbox"/>	<input type="checkbox"/>	<input type="checkbox"/>	<input type="checkbox"/>
> WIRTGEN PERFORMANCE TRACKER - determining the precision mixing	—	<input type="checkbox"/>	—	<input type="checkbox"/>	—	<input type="checkbox"/>
> WIRTGEN PERFORMANCE TRACKER and AutoTrac™ - determining the precision mixing with satellite-based steering system	—	<input type="checkbox"/>	—	<input type="checkbox"/>	—	<input type="checkbox"/>
> Powerful high-pressure water cleaner, 150 bar, 15 l/min	<input type="checkbox"/>	<input type="checkbox"/>	<input type="checkbox"/>	<input type="checkbox"/>	<input type="checkbox"/>	<input type="checkbox"/>
> Additional water tank, 950 liters	—	—	<input type="checkbox"/>	<input type="checkbox"/>	<input type="checkbox"/>	<input type="checkbox"/>
> Battery-operated hydraulic unit	<input type="checkbox"/>	<input type="checkbox"/>	<input type="checkbox"/>	<input type="checkbox"/>	<input type="checkbox"/>	<input type="checkbox"/>
> Milling drum rotation device	<input type="checkbox"/>	<input type="checkbox"/>	<input type="checkbox"/>	<input type="checkbox"/>	—	—
> Pneumatic hammer with pick extractor / inserter	<input type="checkbox"/>	<input type="checkbox"/>	<input type="checkbox"/>	<input type="checkbox"/>	<input type="checkbox"/>	<input type="checkbox"/>
> Hydraulic pick ejector	<input type="checkbox"/>	<input type="checkbox"/>	<input type="checkbox"/>	<input type="checkbox"/>	<input type="checkbox"/>	<input type="checkbox"/>
> Additional storage compartment for pick containers	<input type="checkbox"/>	<input type="checkbox"/>	<input type="checkbox"/>	<input type="checkbox"/>	<input type="checkbox"/>	<input type="checkbox"/>
> Diesel tank filling pump with 2 ft 8 in (7.50 m) suction hose	<input type="checkbox"/>	<input type="checkbox"/>	<input type="checkbox"/>	<input type="checkbox"/>	<input type="checkbox"/>	<input type="checkbox"/>
> Wiggins fast-fill system for diesel refueling	<input type="checkbox"/>	<input type="checkbox"/>	<input type="checkbox"/>	<input type="checkbox"/>	<input type="checkbox"/>	<input type="checkbox"/>
> License plate holder with LED lighting	<input type="checkbox"/>	<input type="checkbox"/>	<input type="checkbox"/>	<input type="checkbox"/>	<input type="checkbox"/>	<input type="checkbox"/>
> Suction hose for hot bitumen 4", 4000 LG	—	—	<input type="checkbox"/>	<input type="checkbox"/>	<input type="checkbox"/>	<input type="checkbox"/>
> Suction hose for water or emulsion 3", 5000 LG	—	—	<input type="checkbox"/>	<input type="checkbox"/>	<input type="checkbox"/>	<input type="checkbox"/>
> Push bar (additional)	<input type="checkbox"/>	<input type="checkbox"/>	<input type="checkbox"/>	<input type="checkbox"/>	<input type="checkbox"/>	<input type="checkbox"/>
> Connection pipe for the intake manifolds with dual ESL	<input type="checkbox"/>	<input type="checkbox"/>	<input type="checkbox"/>	<input type="checkbox"/>	<input type="checkbox"/>	<input type="checkbox"/>
> Support arm for holding the push bar and feed lines whilst changing tankers	<input type="checkbox"/>	<input type="checkbox"/>	<input type="checkbox"/>	<input type="checkbox"/>	<input type="checkbox"/>	<input type="checkbox"/>

■ = Standard equipment

■ = Standard equipment, can be replaced with optional equipment if desired

□ = Optional equipment

**WIRTGEN GmbH**

Reinhard-Wirtgen-Str. 2
53578 Windhagen
Germany

T: +49 2645 131-0
F: +49 2645 131-392
M: info@wirtgen.com

 www.wirtgen.de



For further information, please scan the code.