



Powerful and comfortable

# HC SERIES

HC 110(i) - HC 250(i)



# MAXIMUM PRODUCTIVITY

Efficient compaction over large areas and on steep slopes

Founded in 1878, HAMM has focused on the manufacture of rollers for road building since the beginning of the 20th century. From that time on, HAMM has been the driving force and trendsetter in the industry. Many technologies and solutions that have become the standard in the compaction sector were developed by HAMM.

With the compactors from the HC series, HAMM is continuing this development, as they achieve outstanding compaction power on any construction site. A sophisticated design, powerful travel and vibration drives, plus plenty of traction and torque, even on difficult grounds and steep terrain, ensure efficient, high-quality compaction.

All HC compactors offer drivers a comfortable workstation with intuitive operation thanks to Easy Drive and perfect visibility. HAMM also uses environmentally friendly machine technology - all models come with the HAMMTRONIC machine control system. Its benefits include a low fuel consumption, which reduces costs and emissions. The HC series is pioneering when it comes to the digital future, too. Thanks to integrated interfaces, it can communicate with Smart Doc from HAMM and with other documentation systems that are available on the market.



## HAMM PRODUCT RANGE

### ARTICULATED TANDEM ROLLERS

- > Drum width: 31 - 84 in
- > Operating weight: 1.5 - 14 t

### PIVOT-STEERED TANDEM ROLLERS

- > Drum width: 59 - 66 in
- > Operating weight: 7 - 9 t

### SOIL COMPACTORS

- > Drum width: 54 - 84 in
- > Operating weight: 5 - 26 t

### PNEUMATIC-TIRE ROLLERS

- > Width over tires: 44 - 72 in
- > Operating weight: 4 - 27 t

# OVERVIEW OF THE HIGHLIGHTS

## Perfectly equipped

### 01 Operation and comfort

- > Plenty of room and a high level of comfort
- > Optimal ergonomic working conditions thanks to the Easy Drive operating concept
- > Safe, intuitive operation thanks to clear, language-neutral operating elements

### 02 Compaction quality

- > High linear load and centrifugal force
- > Homogeneous compaction thanks to constant speed
- > Automatic vibration system

### 03 Driving and steering

- > 3-point articulation for superb directional stability
- > Outstanding driving stability
- > Traction control for optimal working on all grounds
- > Optimized steering
- > Integrated articulated joint lock
- > Large slope angles
- > Speed preselect and cruise control
- > Precise and easy reversing

### 04 Visibility

- > Outstanding overview of the machine and the construction site environment from any seating position
- > Mirrors for near-field monitoring
- > Exterior mirror can be adjusted from the driver's seat
- > Bright, energy-saving lighting

### 05 Eco-friendliness

- > ECO mode in every exhaust emissions category
- > Automatic engine stop
- > Reduced nominal speed lowers fuel consumption and noise emissions
- > Power-dependent cooling
- > Use of HVO fuels

### 06 Digital future

- > Smart Doc with GNSS
- > Telematics interface
- > JDLink

### 07 Variants and options

- > C version for heavy-duty use
- > Models with smooth and padfoot drums
- > Comfort options for all climate zones



- + > Outstanding design
- + > Environmentally friendly operation
- + > HAMMTRONIC intelligent control system
- + > Smart Compaction



HAMM SUSTAINABILITY describes innovative technologies and solutions which are consistent with the sustainability objectives of the WIRTGEN GROUP.

# AN OPTIMUM WORKSTATION

Very spacious, very comfortable

## Easy to board

You can even see it from the comfort access to the operator's platform. The HC series compactors offer operators many convenient features. Three steps and an anti-slip edge on the threshold allow drivers to climb up comfortably and safely, to find a well-appointed workstation awaiting them.

## Easily find the perfect position

The HAMM Easy Drive operating concept simplifies operation and ensures a healthy sitting posture. The height, seat suspension and position of the armrest can be adjusted. This allows each and every user to find their optimum position for long, concentrated working. The seat can be optionally supplied with air suspension, a high backrest, a backrest extension and fabric covers.

In addition, there are many practical features, for example the 12 V sockets for a cool box or charging a mobile phone, a compartment in the armrest for a mobile phone, two USB ports, storage space, cup holders and numerous fresh air nozzles.

## Ergonomics included

The steering column forms a unit together with the dashboard and steering wheel, and its tilt can be precisely adjusted in small increments. There is also the option to adjust its height. To make the workstation as quiet as possible, the operator's platform has a molded floor mat with integrated sound insulation.

## XXL workstation

Different regions place different requirements on a compactor. This is why the HC series is available with a cabin or an open operator's platform. A protective roof can be added to the models with open platform. The workstation in all versions is extremely spacious. Tall drivers will be especially happy about the spacious footwell and the excellent headroom. The driver's seat can optionally be rotated in either direction: Clockwise by 70°, counter-clockwise by 10°. Thanks to the adapter for the rotating seat (option) with an innovative rotating and moving mechanism, operators benefit from even more freedom of movement.

## Comfortable cabin

Convex front and rear windows in the cabin make even more space available. Sixteen air outlets ensure agreeable temperature control and a supply of fresh air in any weather conditions. An air-conditioning system is also available as an option. Sliding windows in the cabin also enable the rear-view mirrors to be easily adjusted.

At cold temperatures, ventilation slots ensure fast deicing, while the rear window is also heated. In addition to the standard heating, the cabin can be equipped with an auxiliary heater. It preheats the engine and cabin and keeps running even if the automatic engine stop has switched off the diesel engine to save fuel.



The HC series compactors with an open operator's platform can be equipped with an ROPS bracket and protective roof.



**XXL panoramic cabin**  
spacious, with a lot of headroom

**ROPS/FOPS**  
as standard for all cabins

**Rear-view mirrors**  
easy to adjust, heated on request

# FOLLOW YOUR INTUITION

Work safely and efficiently

## Simply logical, simply language-neutral

Straightforward operation is one of the hallmarks of HAMM rollers. One of the key elements: No language knowledge is needed to understand the displays. Clear symbols and the logical layout are a major contribution to intuitive operation.

The HC series also impresses in terms of its ergonomics. The seat can be adjusted in a variety of different ways. The same applies to the position of the steering column with the steering wheel in the center. It can be adapted in next to no time as the steering column can be tilted and there is also the option to adjust its height.

## Clear and simple thanks to Easy Drive

Easy Drive is HAMM's modern operating concept. It stands out thanks to its simple, easy-to-learn operation and outstanding comfort. For example, all Easy Drive rollers are steered using a steering wheel. The other main functions are controlled via a joystick and the speed preselection wheel.

All operating elements are positioned to allow the driver to operate the compactor quickly and easily.

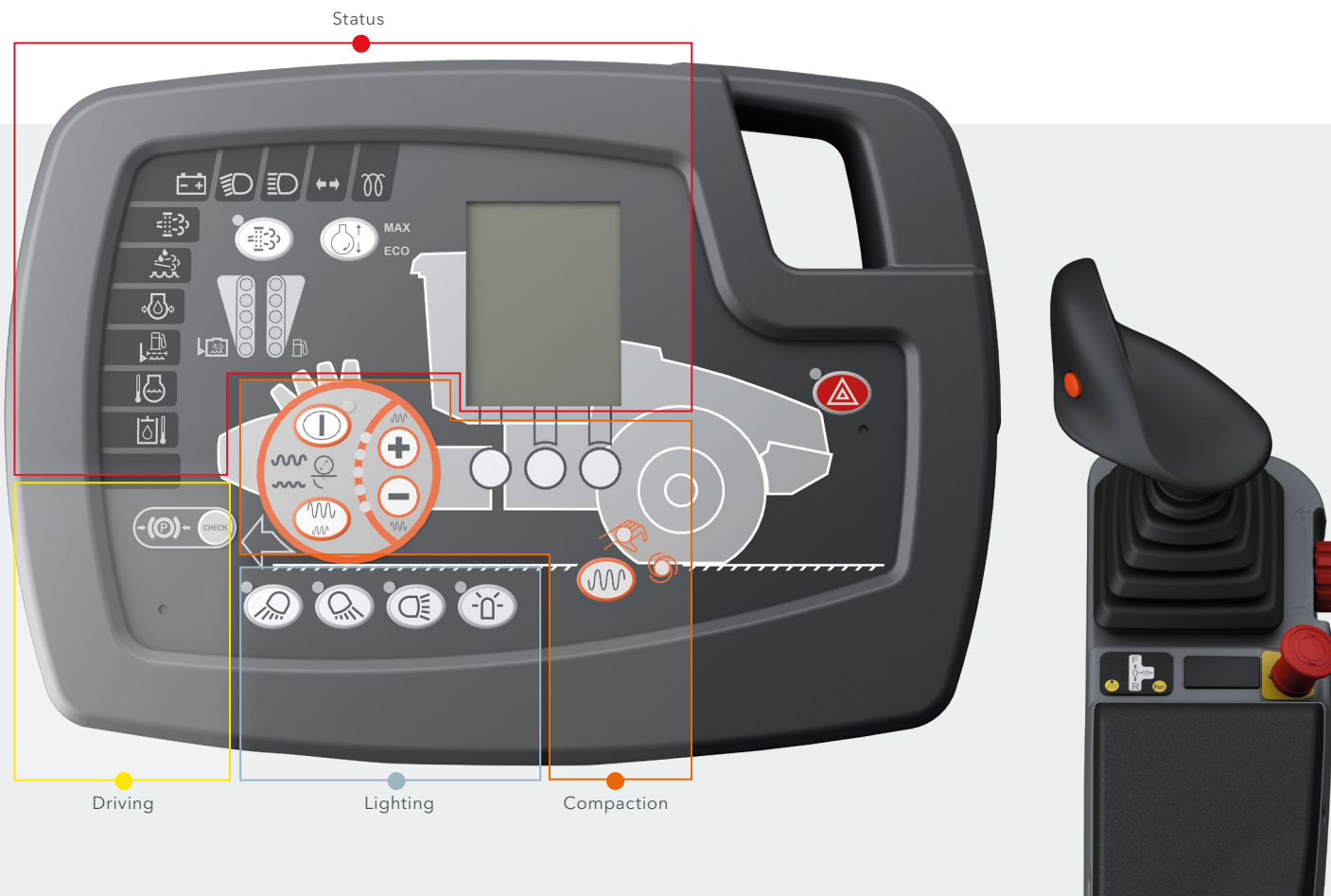

The dashboard in front of the steering wheel contains status and parameter displays as well as infrequently used buttons. All displays and switches are grouped into functional units with color markings. This makes operation easier, since the same applies here as it does to all other HAMM rollers: Same color - same functional group.

Drive control is by means of a joystick on the multifunction armrest.

The important buttons are visible at all times in the spacious Easy Drive operator's platform. The idea behind all other operating elements is that, the more often they are used, the closer to the joystick they are located.

## EXCELLENT VIEW

Everything in view, everything under control



### Cabin with perfect all-round visibility

From the large cabin, the operators have an unobstructed view of the working area directly around the roller, the drum and the surrounding construction site. All models meet the current field of vision standards, even without cameras.

The distribution of the windows is practical.

A sliding window makes it possible to adjust the exterior mirror simply and safely from the driver's seat. A positive side effect is that the cabin ventilation can be modified quickly and easily.

### Keep an eye on the rear of the vehicle too

In all HC series models, the combination of an ingenious frame design and a slender engine hood with view channel provides drivers with a clear view of the ground to be compacted. There are no pillars blocking the driver's view. The exhaust pipe has also been placed so as not to obstruct the field of vision.

There is a small additional mirror facing downwards for a view of the vicinity. A camera system can also be installed on request. This visibility contributes to the compaction quality and ensures a high level of safety.

### Work safely, even in the dark

Powerful spotlights provide ample illumination of the working area even after dark. HAMM relies completely on economical and bright LED lights for the work lighting and rotating beacon.

For operation on public roads, there are various LED lighting packages tailored to national regulations.

The Coming Home function ensures additional safety. After switching off the machine, the light remains switched on for a brief period before the spotlights are deactivated automatically. The illuminated area around the roller makes it easier for drivers to find their way back in the dark.

### Windows that are always clear

Inside, the window heater ensures an unimpeded view to the front and back.

Large windscreen wipers ensure perfect visibility on the outside. They can operate in different settings thanks to interval mode.

# NO COMPROMISES

High-quality and cost-effective compaction

## The right compaction system for every application

Drums with different exciter systems are available for the HC series compactors. Alongside the traditional vibrating roller drum for all weight classes, there are also models with a VIO drum. They can compact using vibration or oscillation.

## Padfoot drums

Compactors with a padfoot drum are often the number one choice when compacting very cohesive soils. The padfoot shells offer incredible flexibility, as they can be used to convert any smooth drum to a padfoot drum in next to no time.

## Effective scrapers

The design of the HC series front vehicle prevents material from building up on the drum. Firstly, the clearance between the drum and crossbeam is exceptionally large. Secondly, the position of the scrapers has been optimized accordingly. This does away with the need for timeconsuming cleaning of the drums. This ultimately increases productivity.

## Variety of drums in all weight classes

The HC series rollers are available with different drums and compaction systems:



Smooth drum



Padfoot drum

## Compaction systems

### Compaction with vibration

- > Vibrating roller drums can work with small or big amplitude

### VIO: Compaction with vibration or oscillation

- > Vibration with big amplitude
- > Switch between vibration and oscillation from the operator's platform

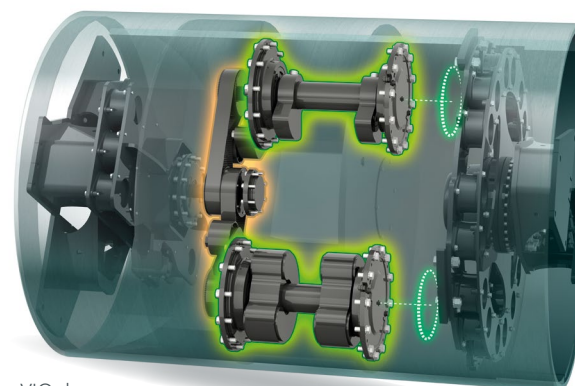

VIO drum

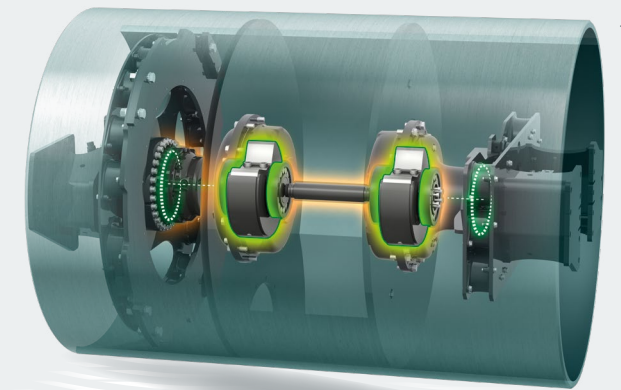

Vibrating roller drum

## Vibration and oscillation

The compactors compress the ground due to their weight, which acts on the ground during the double pass. If the drums begin to vibrate at the same time, the compaction effect increases significantly. This is exactly what happens during compaction with vibration and oscillation.

## Vibration

During vibration, the drum performs a fast, circular movement. This results in the compaction energy being directed vertically into the ground, achieving a powerful depth effect.

## Oscillation

During oscillation, the drum performs a rapidly alternating forwards/backwards rotational movement. This introduces the compaction energy tangentially to the front and back and into the ground. In contrast to a vibrating roller drum, it acts dynamically on the ground all the time. It is always in contact with the ground. This also results in constant static compaction using the machine weight.

## VIO

The VIO drum combines vibration and oscillation in one system. The driver can switch between the two compaction systems while the roller is moving.



## HAMM > ADVANTAGES OF OSCILLATION

### Efficient and cost-effective compaction

- > No over-compaction
- > Homogeneous, level carriageways
- > Dynamic compaction, even in vibration-sensitive areas
- > Low noise level and reduced vibration

# THE ALL-TERRAIN MASTER

Large tanks and reliable system

## Strong on slopes

Large slope angles and powerful drives guarantee that the compactors in the HC series achieve excellent compaction on uneven and steep terrain - even on inclines over 60%. A large clearance between the crossbeam and drum prevents the build-up of material.



The 3-point articulation ensures excellent driving stability and effective shock absorption.

## Quality factor: 3-point articulation

The 3-point articulation developed by HAMM is the key to exceptionally favorable weight distribution and outstanding driving stability. Even when compacting very uneven ground, the articulated joint makes for unrivaled driving comfort. Even with full steering lock, the chassis design ensures excellent shock absorption and even weight distribution between the drum and rear axle. In addition, the risk of tipping when cornering is greatly reduced.

## Modern drive control

The HC series compactors are equipped as standard with the HAMMTRONIC electronic machine management system, which monitors all engine and driving functions. It automatically adjusts the travel and vibration or oscillation drives as well as the engine speed to the current operating conditions. This significantly reduces fuel consumption as well as exhaust gas and noise emissions.

## Concentrated energy

The high static linear load of the HC series compactors - depending on the model, the compactors introduce up to 78 kg/cm into the ground - is the best prerequisite for efficient and fast compaction with great depth effect.

Using the maximum speed preselect that is integrated as standard, cruise control and the electronic driving lever, the compaction force can be metered precisely. Moreover, the reverse assist system helps with changing the direction of travel.

**Large ground clearance**

enables skilful handling

**Large hose protection**

prevents damage to the hydraulic system

**Direct steering**

reduces the steering work

**High traction**

even on rough terrain



# INTELLIGENT ENGINE TECHNOLOGY

Economical power packages - modern and quiet

## Efficient and environmentally friendly

State-of-the-art water-cooled 4-cylinder or 6-cylinder diesel engines provide the HC series compactors with clean power. In all models, the exhaust gas after-treatment complies with the applicable regional regulations.

An intelligent air duct enables the compactors to be operated at ambient temperatures from -20 °C to 50 °C, while the redesigned cooling draws in fresh air right behind the cabin. This keeps the operator's platform and cabin floor cool.

The controllable fans are another benefit. The speed automatically adapts to the demand for cooling air. This reduces the noise emissions of the compactors.

## Optimized fuel consumption without loss of power

All engines work at a lower speed of 2000 rpm instead of 2300 rpm. This means that they generate fewer sound and exhaust gas emissions, without compromising on the usual high compaction power.

The engine power can be called up in two stages: "maximum rpm" mode or ECO mode. In ECO mode, HAMMTRONIC controls the engine speed depending on the load requirement and only increases it as much as is necessary for the current driving or work situation. All other components are then operated in the optimum range, according to the work situation.

The HC series compactors therefore work extremely economically on the whole. The fuel savings compared to predecessor models are 10% (H series) and 20% (3000 series). They can also run on HVO fuels.



## Economical automatic mechanisms

The optional automatic engine stop in the compactors helps cut costs and emissions, because the engine switches off automatically after an extended period of inactivity. This lowers diesel consumption, prevents unnecessary noise emissions and minimizes the number of operating hours. All of this ensures a high level of acceptance and low operating costs.



**Up to 20% less fuel**  
compared to the 3000 series

**High-quality filters**  
long tool life, improved filter effect

**Automatic engine stop**  
reduces emissions

**HAMMTRONIC**  
as standard for all models

# EQUIPPED FOR THE DIGITAL CONSTRUCTION SITE

Technology for the construction sites of the future

## Digital ready

The compactors in the HC series are "digital ready", as with interfaces and compatible hardware they are ready for the applications, quality requirements and communication requirements of the construction sites of the future.

A process data interface can be integrated on the operator's platform for this purpose. The compactors can communicate with digital applications from HAMM and other providers via this standardized interface.

## Always informed

JDLink, the telematics system from John Deere, visualizes the performance data of the rollers in a compact overview in real time. In addition to the machine's live data (such as consumption data or engine load), working hours, position data, error messages and service intervals for the entire fleet can also be accessed anytime, anywhere. Diagnostic codes also enable predictive maintenance planning. This, in turn, helps lower maintenance costs.

## Smart Doc: Assistance for optimal compaction

The "Smart Doc" app combines data from the machine control system with data from the Smart Receiver (GNSS receiver). As a result, important compaction parameters and the compaction progress are displayed and logged.

This creates "compaction maps", which show at a glance the areas which have already been adequately compacted and those which require further compaction. The "Smart Doc" can also be used to document compaction.

## Smart Doc - The quality assurance

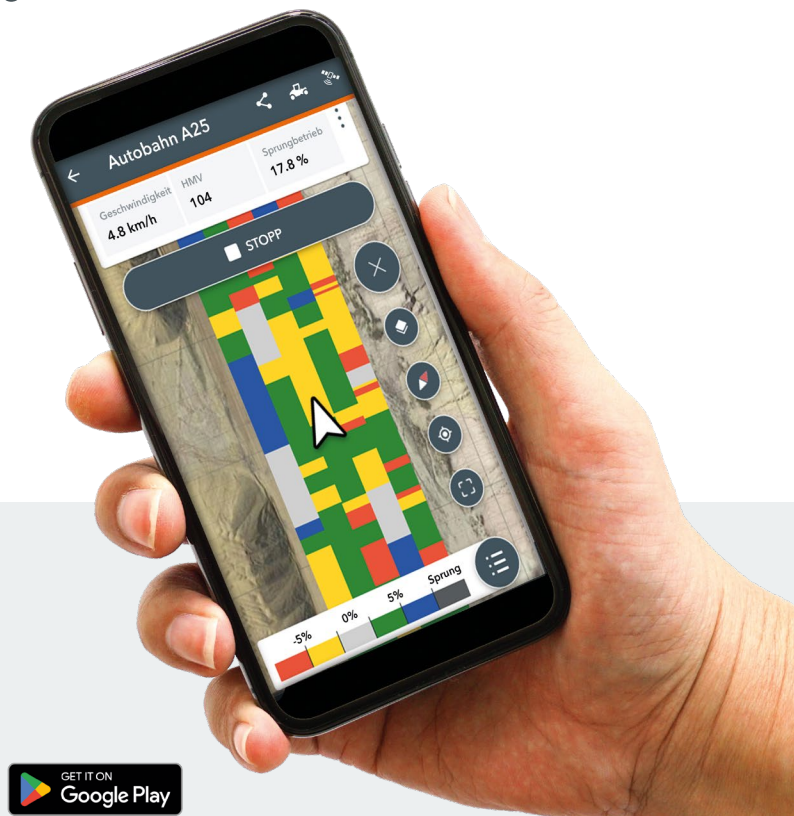
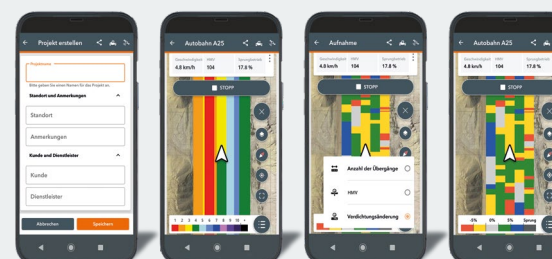
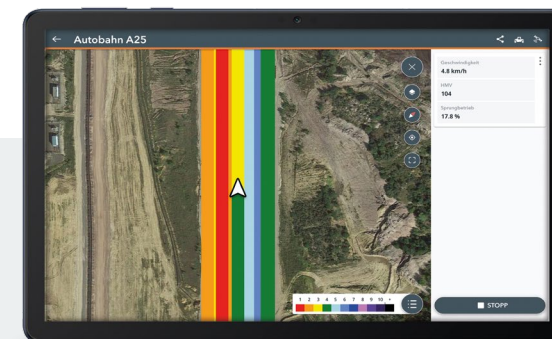

Data is exchanged between the machine control system, Smart Doc and the GNSS receiver via Bluetooth.

# VERSATILITY IS OUR TRUMP CARD

Versatile applications thanks to optional features

## Distribution and compaction: Dozer blades for compactors

The specially shaped dozer blade turns the compactor into a combination unit that can pave and compact smaller volumes of stone without the need for an additional caterpillar vehicle. The dozer blades are available in two variants for models in the HC series, depending on the drum width. The dozer blades can push and distribute materials, while special skids prevent the blades from digging into the ground. In addition, the patented high-visibility cross-member provides an unobstructed view of the area in front of the dozer blade. Very important for the quality of the work is the fact that the dozer blade can also be controlled quickly and extremely sensitively thanks to the proportional valve used.



The dozer blade is available for machines up to 20 t with smooth or padfoot drums.

## Vibration plate

The vibration plate is a practical addition for the 13 t compactors from the HC series. It compacts the ground at a small amplitude and high frequency. This makes it possible to optimize the compaction of non-cohesive soils in particular, which tend to re-loosen. The vibration plate is extremely easy to fit and remove. The electrical and hydraulic system are connected by a single quick-action coupling.

The vibration plate also impresses during operation. All functions can be implemented from the operator's platform using the joystick.



The vibration plate can be moved sideways. This enables compaction, even in critical edge areas.



## C compactors: For tough jobs

The C models with their more powerful drive and up to 30% more torque are especially well suited for challenging tasks in landfill construction or when compacting very heavy, wet or cohesive soils. With anti-slip control and a no-spin axle, the C models offer plenty of traction and gradeability in any driving situation.

Yet they are still economical: Fuel consumption in the C models is almost identical to that in models without more powerful drives because all rollers have the same diesel engine. The high level of torque is also impressive especially when working on slopes and when using the dozer blade.

## CR compactors

The CR models are specially equipped for compaction on rocky ground. Their equipment is based on the C models. However, the drum on the CR models is made from an extremely wear-resistant steel that is more than twice as hard (Brinell hardness).

# EFFICIENT MAINTENANCE

Achieved in just a few steps

## Ergonomic and efficient

The few maintenance tasks required for the HC series compactors can be completed quickly. Here, all service items, oil and water cooling and the battery are easily accessible and grouped together on one side of the machine. The engine hood can be opened and closed extremely easily at the push of a button using the comfort function (option).

Sufficient light is always available for the checks, even in the dark, as the work lighting on the cabin or on the protective roof illuminates the engine compartment perfectly. An especially practical feature is that the side panels on the engine hood are easy to remove without the need for tools.

## Always informed

To ensure fast and thorough servicing, HAMM uses the WIRTGEN GROUP's WIDIAG service diagnostics tool. The interface for this system is easily accessible in the multifunction armrest.

The HC series compactors can be equipped with the JDLink telematics system for remote diagnostics and efficient fleet management.



## Design

Since the 1980s, HAMM has considered design to be a crucial element in product development. And this has proven to be a successful move, as illustrated by the fact that HAMM has, to date, won 40 international design and innovation awards, making it the front runner in the construction industry.



## Environmental protection at every stage

On the construction site, HAMM rollers are impressive thanks to their low fuel consumption. What's more, most models can not only be operated with diesel, but also with non-fossil fuels. HAMM AG's main plant is certified in accordance with ISO 14001, meaning that HAMM is constantly striving to reduce emissions and the use of resources even in the production of rollers.



## HAMMTRONIC

The HAMMTRONIC electronic machine management system monitors all engine and driving functions. It automatically adjusts the travel drive, the vibration or oscillation drive and the engine speed to the current operating conditions. This reduces fuel consumption as well as exhaust and noise emissions.



## Easy Drive

Intuitive operation is at the heart of the Easy Drive operating concept. It is easy to learn and employs the same operating logic in all Easy Drive rollers in which it is installed. In addition, the ergonomically optimized operator's platforms ensure the driver always adopts a healthy posture and seating position.



## Smart Compaction

With Smart Compaction, HAMM has brought together all the key elements required for digitally supported compaction. The systems record relevant parameters as well as position data and use graphs to display work progress. The data can also be exported into a variety of formats for analysis and documentation.



# OPTIONS FOR EVERY EVENTUALITY

Tailored for all applications and regions

**HAMM has thought of everything. Thanks to numerous additional options, the rollers can be precisely adapted to the requirements**

## Automatic engine stop

Automatic engine cut-off after an extended period of inactivity. Saves fuel and hence operating costs.

## HCM (HAMM Compaction Meter)

Displays the HMV value on the dashboard. VIO compactors also available with compaction meter for oscillation compaction.

## Smart Doc

Smartphone or tablet app for compaction control. Helps the driver by providing "compaction maps" with a graphic depiction of the compaction status.

## Frequency control

Precise regulation of vibration frequency in small increments. Meets the requirements of applicable continuous compaction control tenders for targeted reduction of the centrifugal force.

## Dozer blade

Dozer blade with patented high-visibility cross-member for machines up to 20 t with smooth or padfoot drums.

## Vibration plate

For 13 t compactors. Prevents re-loosening in the upper area. Very simple mounting and dismantling. Hydraulic connection via quick-action coupling. Ergonomic joystick-based operation.

## Process data interface

For easy export of the process data (continuous compaction control) in common documentation systems.

## Telematics interface

Standardized telematics interface for the transmission of machine data.

## Work lighting

Four or ten additional LED lights, installed on the front and back of the cabin roof or protective roof.

## Adapter for rotating seat

For even greater freedom of movement, makes it possible to rotate the driver's seat by 70°.

## Comfort seat

With electric height adjustment, lumbar support, air suspension, automatic positioning system and other comfort features.

## Auxiliary heater

Heats the cabin when the engine is switched off.

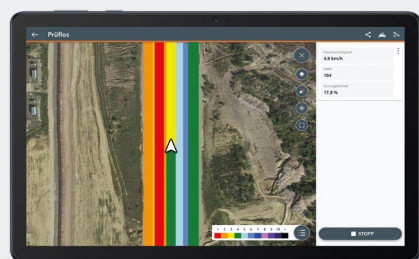

Smart Doc



Adapter for rotating seat

# YOUR WIRTGEN GROUP CUSTOMER SUPPORT

Service you can always rely on.

Place your trust in our reliable and fast support during the complete life cycle of your machine. Our wide service offer includes suitable solutions to meet all of your challenges.



## Service

We keep our service promises – with fast and simple assistance both on the building site as well as in our professional workshops. Our Service team has received expert training. Thanks to special tools, repair, care and maintenance work is completed quickly. Upon request, we can support you with tailored service agreements.

> [www.wirtgen-group.com/service](http://www.wirtgen-group.com/service)



## Spare parts

Original parts and accessories from WIRTGEN GROUP can ensure the high reliability and availability of your machines long term. Our experts will be glad to advise you on application-focused wear part solutions. Our parts are available worldwide, at any time and are easy to order.

> [parts.wirtgen-group.com](http://parts.wirtgen-group.com)



## Training

Staff responsible for the WIRTGEN GROUP's product brands are specialists in their areas and have decades of application experience. Our customers also greatly benefit from these experts. In our WIRTGEN GROUP training courses, we gladly pass on our knowledge to operators and service personnel.

> [www.wirtgen-group.com/training](http://www.wirtgen-group.com/training)



## Telematics solutions

Construction machines with leading technology and perfected telematics solutions work hand-in-hand in the WIRTGEN GROUP. The Operations Center\* – the platform for digital solutions for process, machine and service optimization – allows you not only to simplify maintenance planning for your machines but also to increase your productivity and cost-effectiveness.

> [www.wirtgen-group.com/telematics](http://www.wirtgen-group.com/telematics)

\* John Deere Operations Center™ (formerly WITOS) is currently not available in all countries. Please consult your responsible branch or dealer if you have any questions in this area.

# TECHNICAL SPECIFICATIONS OVERVIEW



## HC SERIES

Basic data				Drums/variants			
Machine model	Weight class (t)	Drum width (in)	Horse power (Hp)	V	VIO	P	R
<b>Machines in accordance with the EPA Tier 4 / EU Stage V exhaust emission standard</b>							
HC 110i	11	84	114	•		•	
HC 110i C	11	84	114	•		•	
HC 120i	12	84	114	•		•	
HC 120i C	12	84	114	•		•	
HC 130i	13	84	160	•	•	•	
HC 130i C	13	84	160	•		•	
HC 140i	14	84	160	•		•	
HC 160i	16	84	160	•		•	
HC 160i C	16	84	160	•		•	
HC 180i	17	84	214	•		•	
HC 200i	20	84	214	•			
HC 200i C	20	84	214	•		•	
HC 250i C	25	84	214	•		•	•

V Vibration  
 VIO Drum with vibration or oscillation  
 P Padfoot drum  
 C "Climbing" equipment for increased gradeability  
 R "rock" - equipment with particularly wear-resistant drum

**WIRTGEN AMERICA**

6030 Dana Way  
Antioch, TN 37013  
USA

T: 1 615 501 0600  
info.america@wirtgen-group.com

 [www.wirtgen-group.com/america](http://www.wirtgen-group.com/america)



For further information, scan the code or visit  
[www.wirtgen-group.com/products-hamm](http://www.wirtgen-group.com/products-hamm)